



MUSIC SYNTHESIZER
SYNTHÉTISEUR MUSICAL
SINTETIZADOR MUSICAL

MONTAGE M6

MONTAGE M7

MONTAGE M8X

Quick Guide

Guide rapide

Guía rápida

English

Français

Español

EN
FR
ES

FCC INFORMATION (U.S.A.)

1. IMPORTANT NOTICE: DO NOT MODIFY THIS UNIT!

This product, when installed as indicated in the instructions contained in this manual, meets FCC requirements. Modifications not expressly approved by Yamaha may void your authority, granted by the FCC, to use the product.

2. IMPORTANT:

When connecting this product to accessories and/or another product use only high quality shielded cables. Cable/s supplied with this product MUST be used. Follow all installation instructions. Failure to follow instructions could void your FCC authorization to use this product in the USA.

3. NOTE:

This product has been tested and found to comply with the requirements listed in FCC Regulations, Part 15 for Class "B" digital devices. Compliance with these requirements provides a reasonable level of assurance that your use of this product in a residential environment will not result in harmful interference with other electronic devices. This equipment generates/uses radio frequencies and, if not installed and used according to the instructions found in the users manual, may cause interference harmful to the operation of other electronic devices. Compliance with FCC regulations does not guarantee that interference will not occur in all installations. If this product is found to be the source of interference, which can be determined by turning the unit "OFF" and "ON", please try to eliminate the problem by using one of the following measures:

- Relocate either this product or the device that is being affected by the interference.
- Utilize power outlets that are on different branch (circuit breaker or fuse) circuits or install AC line filter/s.
- In the case of radio or TV interference, relocate/reorient the antenna. If the antenna lead-in is 300 ohm ribbon lead, change the lead-in to co-axial type cable.

If these corrective measures do not produce satisfactory results, please contact the local retailer authorized to distribute this type of product. If you cannot locate the appropriate retailer, please contact Yamaha Corporation of America, 6600 Orangethorpe Ave., Buena Park, CA90620, USA.

The above statements apply ONLY to those products distributed by Yamaha Corporation of America or its subsidiaries.

(529-M04 FCC class B YCA 01)

COMPLIANCE INFORMATION STATEMENT (Supplier's declaration of conformity procedure)

Responsible Party: Yamaha Corporation of America

Address: 6600 Orangethorpe Ave. Buena Park Calif. 90620

Telephone: 714-522-9011

Type of Equipment: Music Synthesizer

Model Name: MONTAGE M6, MONTAGE M7, MONTAGE M8x

This device complies with Part 15 of the FCC Rules.

Operation is subject to two following conditions:

- 1) this device may not cause harmful interference, and
- 2) this device must accept any interference received including interference that may cause undesired operation.

(529-M02 FCC sdoc YCA 01)

IMPORTANT

Please record the serial number of this unit in the space below.

Model

Serial No.

The serial number is located on the bottom or rear of the unit. Retain this Quick Guide in a safe place for future reference.

* This applies only to products distributed by YAMAHA CORPORATION OF AMERICA.

(84-M01 Ser.No)

Information for users on collection and disposal of old equipment:



This symbol on the products, packaging, and/or accompanying documents means that used electrical and electronic products should not be mixed with general household waste.

For proper treatment, recovery and recycling of old products, please take them to applicable collection points, in accordance with your national legislation.

By disposing of these products correctly, you will help to save valuable resources and prevent any potential negative effects on human health and the environment which could otherwise arise from inappropriate waste handling.

For more information about collection and recycling of old products, please contact your local municipality, your waste disposal service or the point of sale where you purchased the items.

For business users in the European Union:

If you wish to discard electrical and electronic equipment, please contact your dealer or supplier for further information.

Information on Disposal in other Countries outside the European Union:

This symbol is only valid in the European Union. If you wish to discard these items, please contact your local authorities or dealer and ask for the correct method of disposal.

(58-M02 WEEE en 01)

PRECAUTIONS

PLEASE READ CAREFULLY BEFORE PROCEEDING

Please keep this manual in a safe and handy place for future reference.

WARNING

Always follow the basic precautions listed below to avoid the possibility of serious injury or even death from electrical shock, short-circuiting, damages, fire or other hazards. These precautions include, but are not limited to, the following:

Power supply

- Do not place the power cord near heat sources such as heaters or radiators. Also, do not excessively bend or otherwise damage the cord, or place heavy objects on it.
- Do not touch the product or the power plug during an electrical storm.
- Use only the correct voltage specified for the product. The required voltage is printed on the name plate of the product.
- Use only the supplied power cord/plug. Do not use the power cord/plug for other devices.
- Check the power plug periodically and remove any dirt or dust which may have accumulated on it.
- Insert the power plug firmly all the way into the AC outlet. Using the product when it is not plugged in sufficiently can cause dust to accumulate on the plug, possibly resulting in fire or skin burns.
- When setting up the product, make sure that the AC outlet you are using is easily accessible. If some trouble or malfunction occurs, immediately turn off the power switch and disconnect the plug from the outlet. Even when the power switch is turned off, as long as the power cord is not unplugged from the wall AC outlet, the product will not be disconnected from the power source.
- Do not connect the product to an electrical outlet using a multi-plug outlet extender. Doing so can result in lower sound quality, or possibly cause overheating in the outlet.
- When disconnecting the power plug, always hold the plug itself and not the cord. Pulling by the cord can damage it and cause electric shocks or a fire.
- If not using the product for long periods of time, be sure to pull the power plug from the AC outlet.
- Be sure to connect to an appropriate outlet with a protective grounding connection. Improper grounding can result in electrical shock.

Do not disassemble

- This product contains no user-serviceable parts. Do not attempt to disassemble the internal parts or modify them in any way.

Water warning

- Do not expose the product to rain, use it near water or in damp or wet conditions, or place on it any containers (such as vases, bottles or glasses) containing liquids which might spill into any openings or places where water may drop. A liquid such as water getting into the product may cause a fire, electric shocks, or malfunctions.
- Never insert or remove a power plug with wet hands.

Fire warning

- Do not place any burning items or open flames near the product, since they may cause a fire.

If you notice any abnormality

- If any of the following problems occur, immediately turn off the power switch and disconnect the power plug from the outlet.
Finally have the device inspected by Yamaha service personnel.
 - The power cord or plug becomes frayed or damaged.
 - Unusual smells or smoke are emitted.
 - Some object, or water has been dropped into the product.
 - There is a sudden loss of sound during use of the product.
 - Cracks or other visible damage appear on the product.

CAUTION

Always follow the basic precautions listed below to avoid the possibility of physical injury to you or others, or damage to the product or other property. These precautions include, but are not limited to, the following:

Location

- Do not place the product in an unstable position or a location with excessive vibration, where it might accidentally fall over and cause injury.
- Do not go near the product during an earthquake. Strong shaking during an earthquake could cause the product to move or tip over, resulting in damage to the product or its parts, and possibly causing injury.
- When transporting or moving the product, always use two or more people. Attempting to lift the product by yourself may result in injuries, such as back injuries, or cause the product to be dropped and broken, which could lead to other injuries.
- Before moving the product, remove all connected cables, to prevent damage to the cables or injury to anyone who might trip over them.

Connections

- Before connecting the product to other electronic components, turn off the power for all components. Before turning the power on or off for all components, set all volume levels to minimum.
- Be sure to set the volumes of all components at their minimum levels and gradually raise the volume controls while playing the product to set the desired listening level.

Yamaha cannot be held responsible for damage caused by improper use or modifications to the product, or data that is lost or destroyed.

Always turn the power off when the product is not in use.

Handling

- Do not insert foreign materials such as metal or paper into any openings or gaps of the product. Failure to observe this may cause a fire, electric shocks, or malfunctions.
- Do not rest your weight on, or place heavy objects on the product, and do not use excessive force on the buttons, switches or connectors.
- Do not use the product or headphones for a long period of time at a high or uncomfortable volume level, since this can cause permanent hearing loss. If you experience any hearing loss or ringing in the ears, consult a physician.
- Remove the power plug from the AC outlet before cleaning the unit. Failure to observe this may cause electric shocks.

(DMI-11)

NOTICE

To avoid the possibility of malfunction/ damage to the product, damage to data, or damage to other property, follow the notices below.

■ Handling

- Do not use this product in the vicinity of a TV, radio, stereo equipment, mobile phone, or other electric devices. Otherwise, this product, TV, or radio may generate noise.
- When you use the product along with an app on your smart device, such as a smartphone or tablet, we recommend that you enable "Airplane Mode" on the device to avoid noise caused by communication.
- Do not expose the product to excessive dust or vibrations, or extreme cold or heat (such as in direct sunlight, near a heater, or in a car during the day) to prevent the possibility of disfiguration, damage to the internal components or unstable operation.
- Do not place vinyl, plastic or rubber objects on the product, since this might discolor the product.

■ Maintenance

- When cleaning the product, use a soft and dry/slightly damp cloth. Do not use paint thinners, solvents, alcohol, cleaning fluids, or chemical-impregnated wiping cloths.

■ Saving data

- Edited Performance
Edited Performance is lost when you turn off the power to the product without storing it. This also occurs when the power is turned off by the Auto Power Off function (page 31).
- Other settings
Other settings are retained when the power is turned off.
- To save important settings
Keep in mind that Performances and other settings saved to the product may occasionally be lost due to some failure, an operation mistake, etc. For this reason, you should save your important settings onto a USB flash drive (refer to the Operation Manual). Before using a USB flash drive, make sure to see page 32.

Information

■ About copyrights

The copyright of the "content"^{*1} installed in this product belongs to Yamaha Corporation or its copyright holder. Except as permitted by copyright laws and other relevant laws, such as copying for personal use, it is prohibited to "reproduce or divert"^{*2} without the permission of the copyright holder. When using the content, consult with a copyright expert.

If you create music or perform with the contents through the original use of the product, and then record and distribute them, the permission of Yamaha Corporation is not required regardless of whether the distribution method is paid or free of charge.

*1: The word "content" includes a computer program, audio data, Accompaniment Style data, MIDI data, waveform data, voice recording data, music score, and score data, etc.

*2: The phrase "reproduce or divert" includes taking out the content itself in this product, or recording and distributing it without changes in a similar manner.

■ About this manual

- The illustrations and LCD screens as shown in this manual are for instructional purposes only.
- Unless indicated otherwise, the illustrations and screens as shown in this manual are based on the MONTAGE M6 (in English).
- The company names and product names in this manual are the trademarks or registered trademarks of their respective companies.

■ About disposal

When disposing of this product, please contact the appropriate local authorities.

MEMO



Welcome

Thank you for purchasing this Yamaha Music Synthesizer!

This flagship model synthesizer comes with multiple sound engines that make the instrument powerful and versatile for all music genres. We recommend that you read this manual carefully so that you can fully take advantage of the advanced and convenient functions of this instrument. We also recommend that you keep this manual in a safe and handy place for future reference.

About the manuals

The set of documents listed below are included with this instrument.

Printed manual included with this product

■ Quick Guide (this book)

Provides explanations for the basic functions of the instrument.

Website-based manuals

The manuals provided on the website can be downloaded from the Yamaha Downloads. Connect to the Internet and enter the model name "MONTAGE M" in the Model Name or Keyword search box and click Search.



Yamaha Downloads

<https://download.yamaha.com/>

■ Operation Manual (HTML)

Provides instructions on operating the instrument, as well as detailed information on the internal structure and connection of other instruments and devices.

https://manual.yamaha.com/mi/synth/montage_m/index_q.html



■ Data List (.xlsx and .pdf)

This file contains various important lists such as the Performance list, Effect type list, Waveform list, Arpeggio type list, and MIDI implementation chart.

Included accessories

- Power cord (× 1)
- Quick guide (this book)
- *Cubase AI Download Information*
- *Expanded Softsynth Plugin for MONTAGE M download information*

About firmware updates

To implement new functions and improve operability, this instrument may be shipped with an updated version of the firmware installed.

The manual for the updated version of the firmware can be downloaded from the website below.

Yamaha Downloads: <https://download.yamaha.com/>

The firmware version of your keyboard can be checked via [UTILITY] → *Settings* → *System*.

Notation in this document

Model name

In this document, MONTAGE M6, MONTAGE M7, and MONTAGE M8x are collectively called the "MONTAGE M."

NOTE

"NOTE" indicates supplementary descriptions.

Contents

PRECAUTIONS	2
NOTICE	4
Information	4
Welcome	6
About the manuals	6
Printed manual included with this product	6
Website-based manuals	6
Included accessories	6
About firmware updates	7
Notation in this document	7
Features	9
What is the Motion Control Synthesis Engine?	9
Basic Performance structure	10
How Live Set works	11
Live Set bank	11
Panel controls and functions	12
Top panel	12
Rear panel	26
Setting up	30
Power supply	30
Connecting speakers or headphones	30
Turning the instrument ON	
Turning the instrument OFF	31
Auto Power Off function	31
Adjusting the master volume	32
Panel Lock feature	32
Using USB flash drives	32
Preparation for live performance	33
Status check and basic operation	34
Checking the status	34
Opening setting screens	38
Moving the cursor and changing parameter values	39
Icons shown for specific operations	40
Entering characters and numbers	41
Playing the keyboard	44
Selecting a Performance from the Live Set screen	44
Troubleshooting	45
Restoring the factory default settings (Initialize All Data)	45
Specifications	46
Index	47

Features

The MONTAGE M synthesizers feature the built-in *Motion Control Synthesis Engine*, letting you create enormously complex, multi-textured sounds by combining AWM2, FM-X, and AN-X synthesis engines seamlessly and further modifying the sound using Motion control. Therefore, you can use the MONTAGE M, not just for recreating conventional sounds, but also for creating completely new sounds.

What is the *Motion Control Synthesis Engine*?

This is a powerfully comprehensive synthesis system that uses a hybrid, multi-tone-generator sound engine, and sophisticated motion controls with multiple control sources for creating complex and continuously shifting sonic textures.

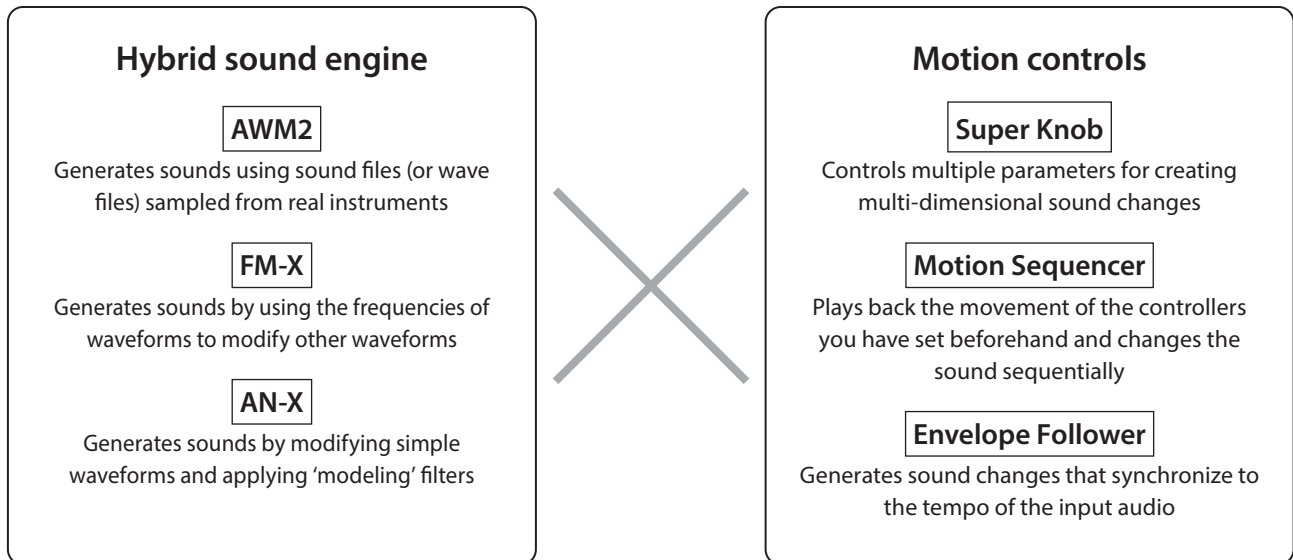

Basic Performance structure

On the MONTAGE M, the group of settings related to a specific sound is called a “Performance.” Select the desired Performance and play the keyboard.

A Performance can consist of up to 16 Parts, with a sound assigned to each Part.

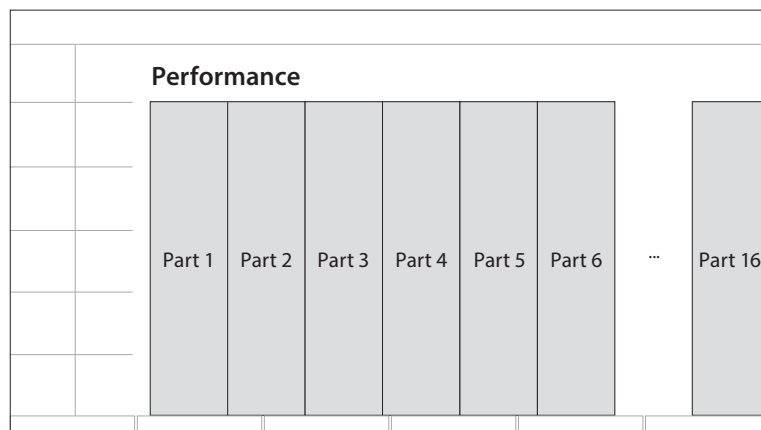

A Performance that contains multiple Parts is called a Multi-Part Performance, while a Performance that contains only one Part is called a Single-Part Performance. Single-Part Performances can be used in the same way as Voices on AWM2 synthesizers.

There are four types of Parts.

■ Normal Parts (AWM2)

Parts played by the AWM2 sound engine. An instrument sound such as piano, organ, guitar, and synthesizer can be assigned to a Part.

■ Normal Parts (FM-X)

Parts played by the FM-X sound engine.

■ Normal Parts (AN-X)

Parts played by the AN-X sound engine.

■ Drum Parts (AWM2)

Parts played by the AWM2 sound engine. A percussion instrument sound can be assigned to the Part. The Drum Parts are used for playing rhythms.

NOTE

- If you wish to create sounds by using default initial values, select an *Init* Performance.
- If you wish to use this instrument as a 16-part multitimbral tone generator, use the *Multi/GM* Performances. These are Performances using all 16 parts, with the drums being assigned to Part 10.

Performances allow you to select a sound for each Part and combine multiple Parts in sophisticated split and layer settings for playing on the keyboard. Moreover, you can create complex sounds by editing the Performances and Parts from the Edit screen and enabling the Motion Control settings.

The created Performance can be saved to internal memory, or to USB flash drives connected to the instrument. You can also use *Soundmondo*, a sound management and sharing service, to save backups for yourself or share your Performances with others.

Soundmondo: <https://www.yamaha.com/2/soundmondo>

By combining the *Expanded Softsynth Plugin for MONTAGE M* (the software version of the MONTAGE M) installed on the computer and the hardware version of the MONTAGE M, you can create and manage many more Performances. The sounds you have used in your DAW for music production and the sounds you have used for live performance are shared between the software and hardware synthesizers.

How Live Set works

MONTAGE M series synthesizers feature a powerful Live Set function for saving and managing the Performances you've created. The Live Set function lets you register the desired MIDI and audio files to play along with the Performances you wish to use on stage.

On the Live Set screen, there are 16 slots per page for saving up to 16 sets of settings. For example, you can register the same Performance with different volume settings to various slots so that you can change the volume of the Performance as the song progresses. That way you can simply tap the slot to switch to the next volume setting as you play live.

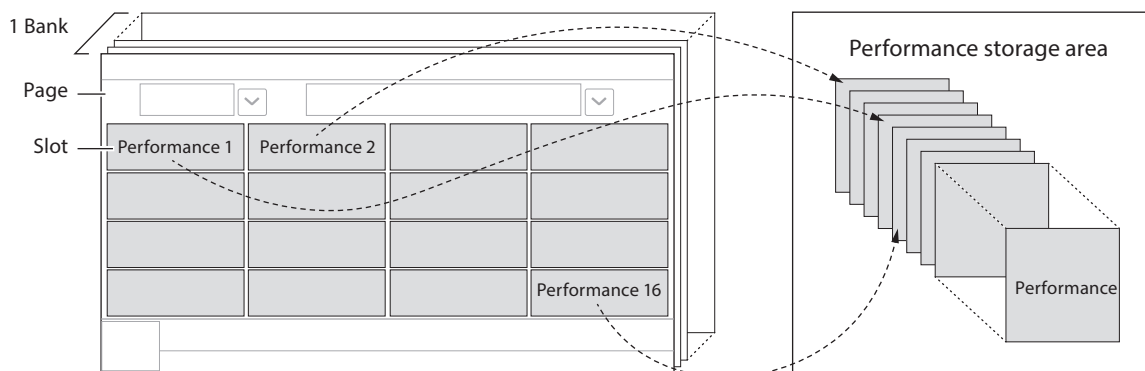

NOTE

A link to the selected Performance is saved to each slot. When a Performance is edited and stored, all slots that have the link to the corresponding Performance will be updated.

Live Set bank

A bank is a set of Live Set pages used for managing Performances. Each bank has 16 pages of Live Sets. There are three types of banks: Preset, User, and Library.

■ Preset bank

The bank for registered preset Performances.

Any Performances in the Preset bank you have edited cannot be saved back to the Preset bank; they must be saved to a User bank.

NOTE

Refer to the "Data list" for the list of Preset Performances.

■ User bank

The bank for registered Performances you've edited yourself. Nothing is contained in this bank when the MONTAGE M is shipped from the factory.

There are eight banks (or 128 pages) available, allowing you to register up to 2,048 Performances.

You can arrange the Performances in your own custom order—for example, according to a setlist in live performance situations.

■ Library bank

The bank for registered Performances from the Library files. Nothing is contained in this bank when the MONTAGE M is shipped from the factory.

You can register one Library file per bank.

Library files can be downloaded from the Yamaha website.

When you first start up the MONTAGE M, the Live Set screen for the Preset bank will be shown on the Main display. The start-up screen can be set to a Live Set or Performance screen as desired ([UTILITY] → System).

Panel controls and functions

This section provides an overview of the panel controls and functions.

Top panel

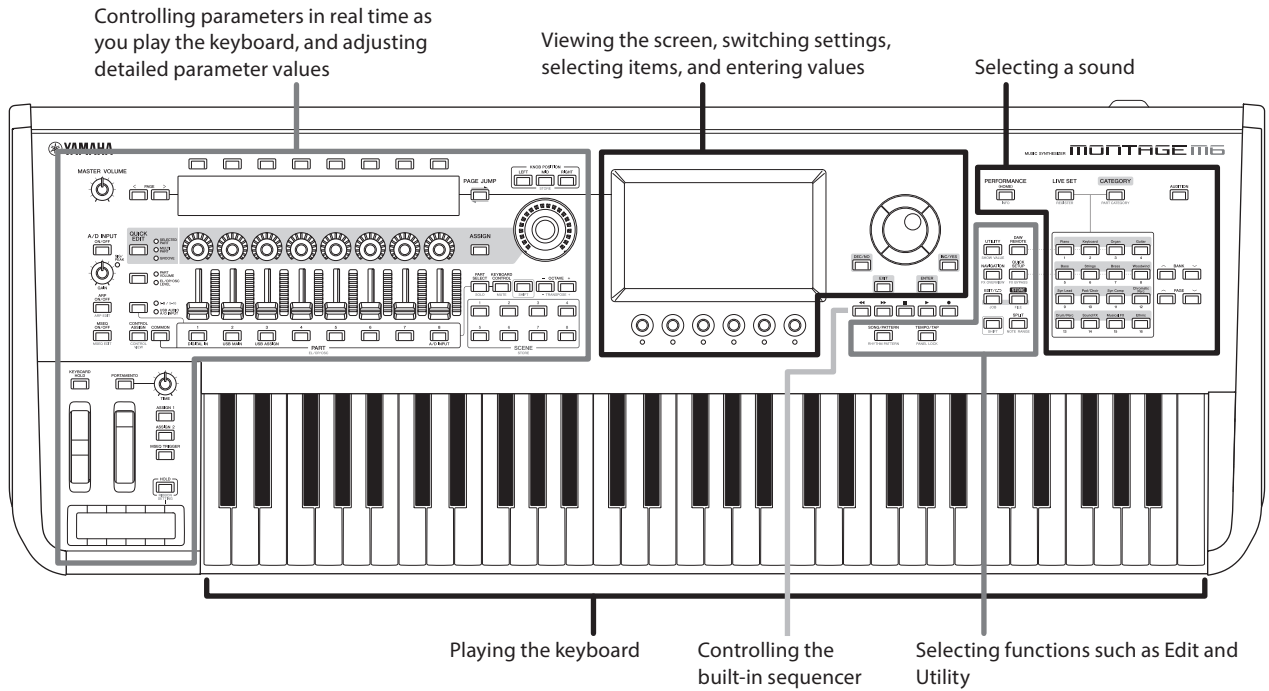

Selecting a sound

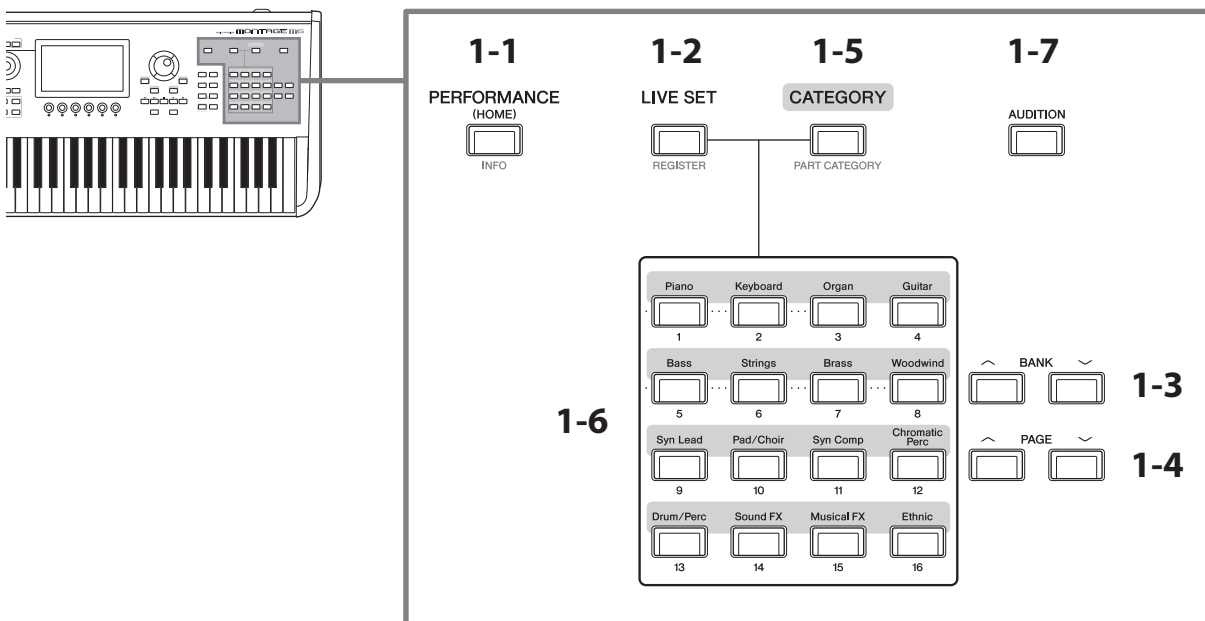

1-1 [PERFORMANCE] button (INFO)

This calls up the Performance screen. You can press this button to switch to a different Performance view.

Pressing this button while holding down the [SHIFT] button calls up the screen for checking relevant information for the Performance (INFO screen).

1-2 [LIVE SET] button (REGISTER)

This calls up the Live Set screen. You can press the same button to select a different Performance bank.

Press this button and then tap the slot on the touchscreen, or use the Slot number and Category name selection buttons to select a slot from the Live Set page currently shown on the screen.

Pressing this button while holding the [SHIFT] button opens the screen for registering the current Performance to the Live Set page. Doing this beforehand allows you to call up Performances quickly and conveniently as you play live.

1-3 BANK buttons

Use these buttons to select a bank.

1-4 PAGE buttons

Use these buttons for selecting a Live Set page.

On the Category Search screen, you can use these buttons to scroll through the list of Performances.

1-5 [CATEGORY] button (PART CATEGORY)

Use this button to call up the Category Search function. Every time you press the button, the next Performance bank is selected.

While the Performance screen is active, pressing this button opens the Performance Category Search screen for selecting a Performance.

When the cursor is on a Part, pressing this button while holding down the [SHIFT] button opens the Part Category Search screen.

1-6 Slot number and Category name selection buttons

When the [LIVE SET] button is selected, you can use these buttons to select one of the Live Set slots, 1 to 16. When the [CATEGORY] button is selected, you can use these buttons to select a category.

Categories and descriptions

Categories	Descriptions
<i>Piano</i>	Piano
<i>Keyboard</i>	Keyboard instruments (such as harpsichord and Clav)
<i>Organ</i>	Organ
<i>Guitar</i>	Guitar
<i>Bass</i>	Bass
<i>Strings</i>	Strings (instruments such as violins, or string ensembles)
<i>Brass</i>	Brass (such as trumpets)
<i>Woodwind</i>	Woodwind instruments (such as clarinets, flues, and saxophones)
<i>Syn Lead</i>	Synth lead (synth sound suitable for playing melodies and soloing)

Categories	Descriptions
<i>Pad/Choir</i>	Synth pad
<i>Syn Comp</i>	Synth comp (synth sounds suitable for "comping")
<i>Chromatic Perc</i>	Chromatic percussion (such as marimba and glockenspiel)
<i>Drum/Perc</i>	Drums, Percussion
<i>Sound FX</i>	Sound effects
<i>Musical FX</i>	Musical effects (pitched sound effects)
<i>Ethnic</i>	Ethnic
<i>No Assign</i>	No assign (not categorized)
<i>Init</i>	Initialized (no settings)

You can also use these buttons to select a setting on the *DAW Remote* or *Quick Setup* screen.

1-7 [AUDITION] button

While one of the Performance, Live Set, or Category Search screens are shown, pressing this button starts or stops the playback of the audition phrase that uses the currently selected Performance.

Selecting functions such as Edit and Utility

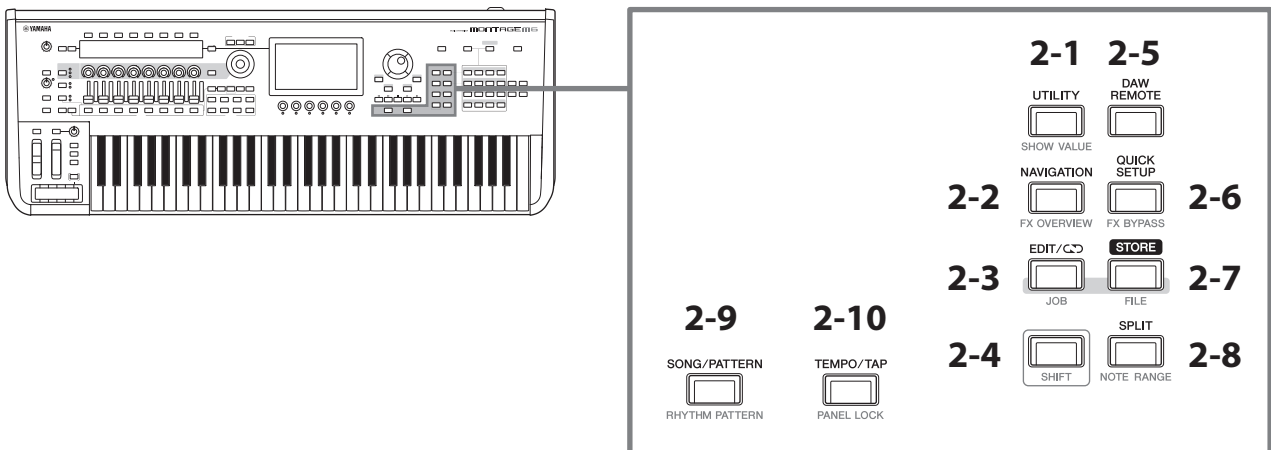

2-1 [UTILITY] button (SHOW VALUE)

This calls up the UTILITY screen where you can change the overall settings for the MONTAGE M.

Pressing this button while holding down the [SHIFT] button shows the values on the Main display or the Sub display if there are any values not shown graphically.

2-2 [NAVIGATION] button (FX OVERVIEW)

According to the Part you are editing, this calls up the map of the corresponding parameters. When you select one item from the map, the parameter setting screen for that item will be shown on the Main display.

Pressing this button while holding down the [SHIFT] button calls up the screen for checking the effect overview (FX OVERVIEW screen).

2-3 [EDIT/C↵] button (JOB)

This calls up the Performance Edit, Live Set Edit or Pattern Edit screen.

While editing the Performance parameters, pressing this button allows you to use the Compare function.

With the Compare function, you can check the sound before and after editing to see how the sound changes.

While the Edit screen is shown, press the [EDIT/C↵] button. The [EDIT/C↵] button flashes, and the settings temporarily revert to the state before the edit. Press the [EDIT/C↵] button again to enable the newly edited settings again.

Pressing this button while holding down the [SHIFT] button calls up the screen for Job settings (JOB screen).

2-4 [SHIFT] button

Hold down this button along with another button enables you to call up the alternate function printed in red at the bottom of each button.

For the list of functions, refer to the Operation Manual.

2-5 [DAW REMOTE] button

This calls up the DAW REMOTE screen for the Performance. You can select the desired *DAW Remote* mode by pressing the Category name number selection buttons located on the right.

2-6 [QUICK SETUP] button (FX BYPASS)

This calls up the *Utility* QUICK SETUP screen. You can select a *Quick Setup* mode by pressing the Category name number selection buttons located on the right.

Pressing this button while holding down the [SHIFT] button calls up the screen for making effect bypass settings (FX BYPASS screen).

2-7 [STORE] button (FILE)

This calls up the Store screen. On the Store screen, you can select to save the Performance under a new name or to overwrite the existing performance.

Pressing this button while holding down the [SHIFT] button calls up the screen for File settings (FILE screen).

2-8 [SPLIT] button (NOTE RANGE)

This calls up the *Split Job* screen for the Performance.

Pressing this button while holding down the [SHIFT] button calls up the screen for setting note ranges (NOTE RANGE screen).

2-9 [SONG/PATTERN] button (RHYTHM PATTERN)

This calls up the *Play/Rec* screen for the Performance.

Pressing this button while holding down the [SHIFT] button calls up the screen for setting Rhythm Patterns (RHYTHM PATTERN screen).

2-10 [TEMPO/TAP] button (PANEL LOCK)

This calls up the *Utility Tempo Settings* screen.

Pressing this button while holding down the [SHIFT] button locks the panel controls. Repeat the operation to unlock the panel controls.

Controlling the built-in sequencer

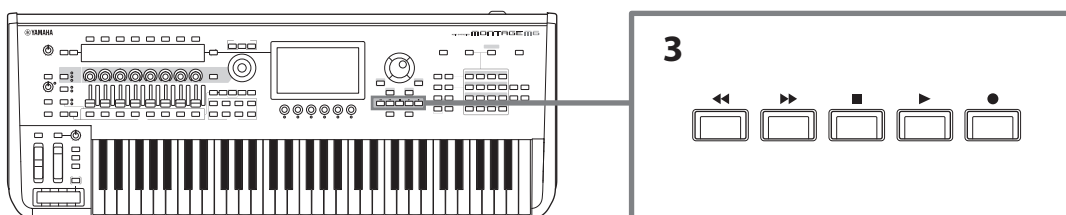

3 Sequencer transport buttons

Use these buttons for controlling playback and recording of the sequencer data for Pattern, Song and Audio.

[◀◀] (Back) button

Use this button for moving back one measure at a time.

[▶▶] (Forward) button

Use this button for moving forward one measure at a time.

[■] (Stop) button

Use this button for stopping playback or recording. If you press this button again while playback is currently stopped, the starting point for playback returns to the beginning of the sequencer data.

You can also use this button to stop Arpeggio playback that continues playing after keys are released (in cases where the Arpeggio Hold switch is on).

[●] (Record) button

This calls up the Recording screen. While the Recording screen is shown, press this button to call up the Recording setup screen (the button starts flashing). When you press the [▶] (Play) button, recording starts, and the button stops flashing and lights continuously.

[▶] (Play) button

Use this button for starting song playback or recording. When playback or recording starts, the button flashes at the tempo of the song. The button lights up continuously for audio.

Viewing the screen, switching settings, selecting items, and entering values

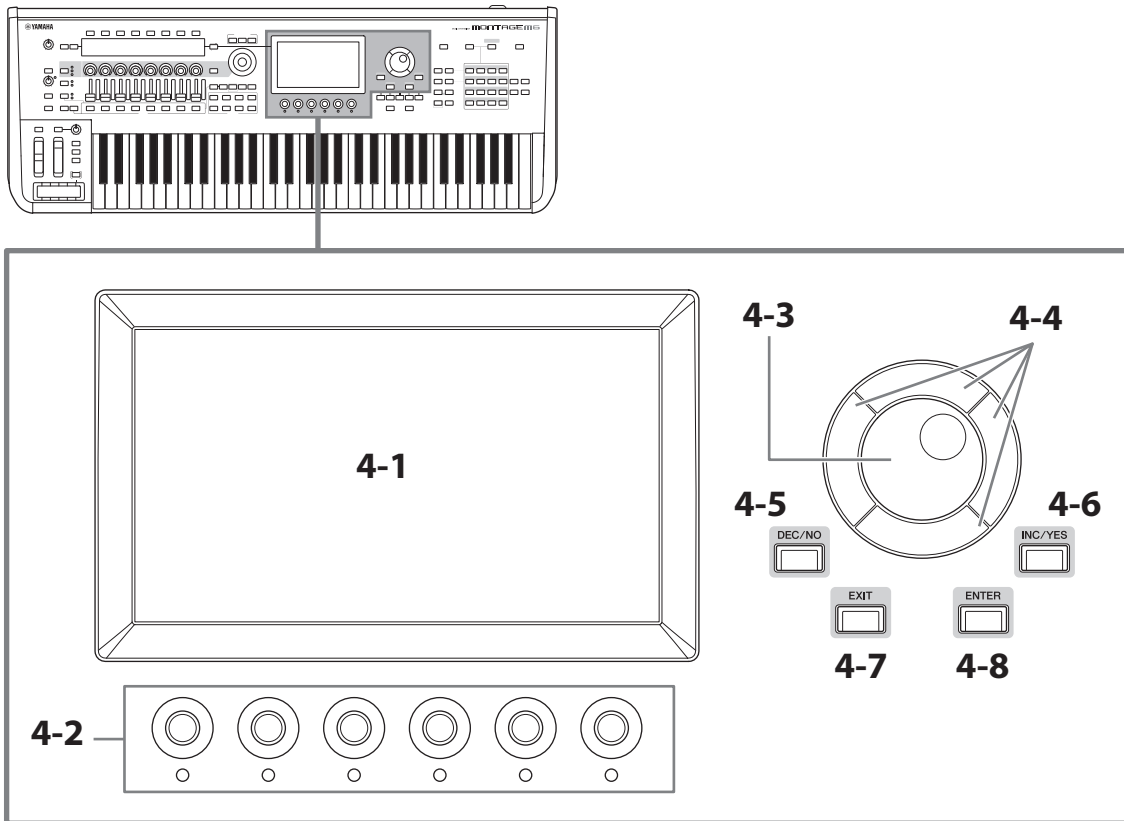

4-1 Main display (touchscreen)

This display shows various information. By touching the screen, you can change the settings.

You can also use the Slot number and Category name selection button, cursor key, data dial, and display knobs to move the cursor and change the value. For details, see "Status check and basic operation" (page 34).

4-2 Display knobs

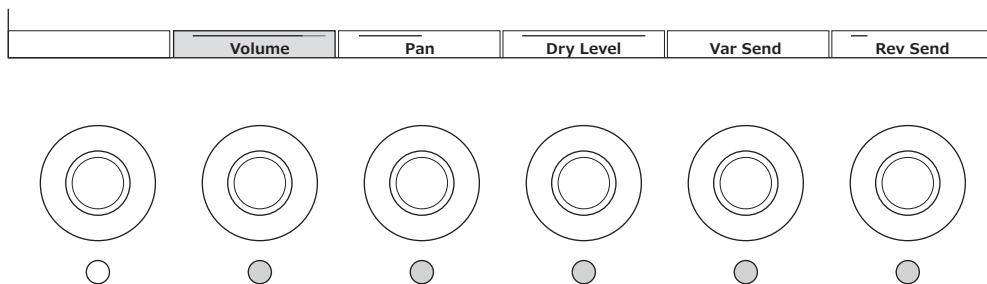

Use these knobs to control the selected row of parameters shown in the Main display. The knobs with the parameter names shown at the bottom of the Main display and with their indicator lamps ON can be used for changing the parameter settings.

4-3 Data dial

Use this dial to change the value shown at the cursor position.
Moving the dial faster lets you change the parameter value in larger increments.

4-4 Cursor buttons

For moving the cursor position up, down, left, and right.

4-5 [DEC/NO] button

Use this button to decrease the value in increments.
You can also use this button to select "NO" for the message shown on the Store or Job screen.
Pressing this button while holding down the [SHIFT] button lets you jump through the values in units of 10.

4-6 [INC/YES] button

Use this button to increase the value in increments.
You can also use this button to select "YES" for the message shown on the Store or Job screen.
Pressing this button while holding down the [SHIFT] button lets you jump through the values in units of 10.

4-7 [EXIT] button

The functions shown on the touchscreen are arranged in hierarchical order. Use this button to return upward on the hierarchical level.
If a Performance screen other than the Home screen is shown, you can use the [EXIT] button to instantly return to the Home screen.

4-8 [ENTER] button

Use this button to call up the item shown/selected on the screen. You can also use this button to select "YES" for prompts or messages shown on the Store or Job screen.

Controlling parameters in real time as you play the keyboard, and adjusting detailed parameter values

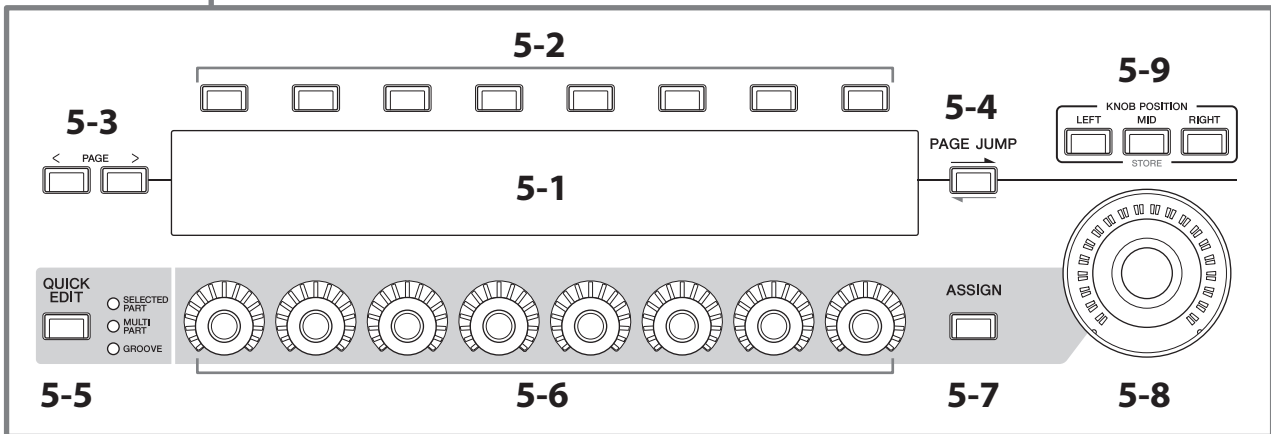
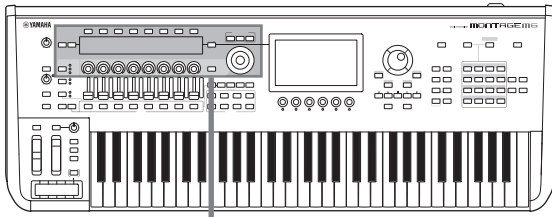

5-1 Sub display

5-2 Tab selection buttons

5-3 Tab PAGE buttons

The parameters controlled with Knobs 1–8 are shown on the separate Sub display. Use the Tab selection buttons and Tab PAGE buttons to switch among the available screens.

Different parameters are available depending on the particular tone generation type for the Part being edited.

5-4 [PAGE JUMP] button

This calls up (on the Main display) the advanced setting screen for the parameter currently being edited on the Sub display.

Pressing this button while holding down the [SHIFT] button enables the parameter being edited on the Main display to be shown on the Sub display as well.

5-5 [QUICK EDIT] button

Select the type of parameters to control with Knobs 1–8. You can press the same button as many times as necessary to switch to a different setting.

Indicator	Description
SELECTED PART	Controls the parameters for the Part being edited
MULTI	Controls the parameters for multiple Parts being edited
GROOVE	Controls the groove-related parameters

When the [ASSIGN] button is turned on, the [QUICK EDIT] button will be turned off.

5-6 Knobs 1–8

By turning these eight knobs, you can control various parameters related to the Part sound, Arpeggio playback, Motion Sequencer, and others. Select the functions for Knobs 1–8 by using the QUICK EDIT button on the left.

5-7 [ASSIGN] button

When this button is activated, Knobs 1–8 are ready to be used as assignable knobs.

5-8 Super Knob

You can use this knob to simultaneously control multiple parameters (*Assign* 1–8) assigned to Knobs 1–8.

You can also control the Super Knob from a connected FC7 foot controller.

For more information on the values controlled with the Super Knob, as well as instructions on how to assign functions to *Assign* 1 to 8 parameters and how to make settings for the foot controller connections, refer to the Operation Manual.

5-9 KNOB POSITION buttons

Use these buttons to view the values corresponding to the Super Knob position to be shown on the Sub display. You can also check the values from [PERFORMANCE] → *Motion Control* → *Super Knob*.

[LEFT] button	The value corresponding to the leftmost position for the Super knob
[MID] button	The value (the center value) corresponds to the mid position for the Super knob The center value can be assigned to any position on the knob. NOTE The [MID] button is available only when the <i>Super Knob Mid Position</i> setting is set to something other than off.
[RIGHT] button	The value corresponding to the rightmost position for the Super knob

Adjust the parameters using Knobs 1–8, and then press this button while holding down the [SHIFT] button to save the settings.

By setting different values for each button, you can set morph transitions using these three reference points.

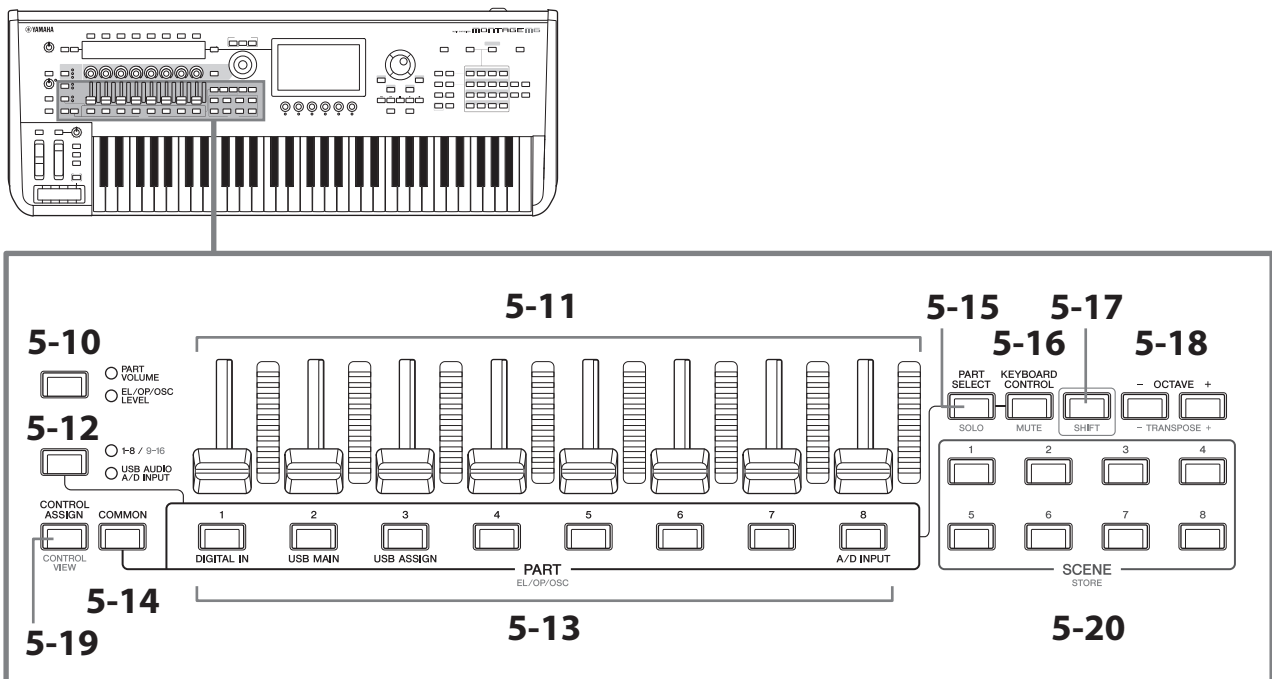

5-10 Slider function [PART VOLUME]/[EL/OP/OSC LEVEL] button

Use this button to set the eight control sliders for controlling the volume of the Parts or the level of the elements, operators, oscillators, or drum keys. Each time you press the button, the slider function alternates between PART VOLUME and EL/OP/OSC LEVEL.

5-11 Control sliders 1–8

Use these sliders for real-time control of the volume for Parts 1–16 (1–8/9–16), elements of Normal Parts (AWM2), operators of Normal Parts (FM-X), oscillators of Normal Parts (AN-X), and keys for the Drum Parts.

When the slider function [PART VOLUME]/[EL/OP/OSC LEVEL] button is set to “EL/OP/OSC LEVEL,” you can use the PART buttons to adjust the levels for the element, operator, oscillator, or drum key of the selected part.

NOTE

- If all Control Sliders are set to the minimum, you may not hear any sound from the instrument, even when playing the keyboard or a Song. If this is the case, move all the sliders to a suitable level.
- The [MASTER VOLUME] knob controls the overall audio output level of this instrument. On the other hand, the Control Sliders control the level of each element/key/operator of the Parts and the volume for each Part of the Performance as a parameter. Accordingly, the values set via the Control Sliders can be stored as Performance data.

5-12 Part group [1-8/9-16]/[USB AUDIO / A/D INPUT] button

Use this button to set the PART buttons for selecting Parts 1 to 16 or for selecting USB AUDIO and A/D INPUT. Each time you press the button, the sliders’ function alternates between 1–8/9–16 and USB AUDIO/ A/D INPUT.

By pressing this button while holding down the [SHIFT] button, you can use the PART buttons to control Parts 9 to 16. When the 1-8/9-16 lamp is on, the PART buttons are set to Parts 1 to 8, and when the 1-8/9-16 lamp is flashing, the PART buttons are set to Parts 9 to 16.

5-13 PART buttons (EL/OP/OSC)

When the Part group [1-8/9-16]/[USB AUDIO / A/D INPUT] button is set to “1-8/9-16,” you can use these buttons to select Parts 1 to 8 or Parts 9 to 16.

When the Part group [1-8/9-16]/[USB AUDIO / A/D INPUT] button is set to “USB AUDIO / A/D INPUT,” you can use these buttons to select DIGITAL IN, USB MAIN, USB ASSIGN, and A/D INPUT.

By pressing one of these buttons while holding down the [SHIFT] button, you can use the appropriate PART button to select *Elements* 1 to 8, *Operators* 1 to 8, *Oscillators* 1 to 3, or *Noise*.

5-14 [COMMON] button

Use this button to select Common operations for the Parts, elements, operators, and oscillators.

5-15 [PART SELECT] button (SOLO)

When the Part group [1-8/9-16]/[USB AUDIO / A/D INPUT] button is set to "1-8/9-16," you can use the PART buttons to select Parts 1 to 8 or Parts 9 to 16. When "USB AUDIO / A/D INPUT" is selected, you can use the appropriate PART buttons to select DIGITAL IN, USB MAIN, USB ASSIGN, and A/D INPUT.

By pressing this button while holding down the [SHIFT] button (so that the SOLO button flashes), and then press the appropriate PART button to set SOLO for the Part on or off.

Also, by pressing the [PART SELECT] button while holding down the [SHIFT] button and then pressing one of the PART buttons while holding down the [SHIFT] button, you can use the appropriate PART button to set SOLO to on or off for the particular Element, Operator, or Oscillator.

When the Part is set to SOLO on, you can see the status with the Solo button or the "S" icon on the screen.

5-16 [KEYBOARD CONTROL] button (MUTE)

Use this button to enable the PART buttons to set the keyboard control for each Part.

When the keyboard control is enabled for the part, the keyboard icon appears enabled on the Main display, and the Part can be played on the keyboard.

By pressing this button while holding down the [SHIFT] button, you can set the Part to MUTE on or off.

Also, by pressing the [KEYBOARD CONTROL] button while holding down the [SHIFT] button and then pressing one of the PART buttons while holding down the [SHIFT] button, you can use the appropriate PART button to set MUTE to on or off for the particular Element, Operator, or Oscillator.

When the Part is set to MUTE on, you can see the status with the Mute button or the "M" icon on the screen.

5-17 [SHIFT] button

Holding down this button along with another button enables you to call up alternate functions, printed in red at the bottom of each button.

For the list of functions, refer to the Operation Manual.

5-18 OCTAVE buttons (TRANSPOSE)

Each time you press a button, the keyboard range moves in octaves.

Pressing this button while holding down the [SHIFT] button allows you to transpose the keyboard. Each time you press one of the buttons, the pitch of the keyboard moves in semitones.

Pressing both buttons at the same time resets the setting to the standard pitch or "0."

5-19 [CONTROL ASSIGN] buttons (CONTROL VIEW)

The CONTROL ASSIGN screen appears.

When a parameter that can be assigned to a controller is selected on the Main display, you can press this button and move the desired controller for parameter assignment to open the setting screen for the controller.

Pressing this button while holding down the [SHIFT] button opens the screen for checking the controller settings (CONTROL VIEW screen).

5-20 SCENE buttons (STORE)

You can assign different "snapshots" of important Part-related parameters such as track mute status and basic Mixing setups to each of the SCENE buttons.

The currently selected button fully lights, the button with stored SCENE setting lights dimly, and the button with no stored SCENE setting is turned off.

By pressing one of these buttons while holding down the [SHIFT] button, you can save the Scene settings you've edited.

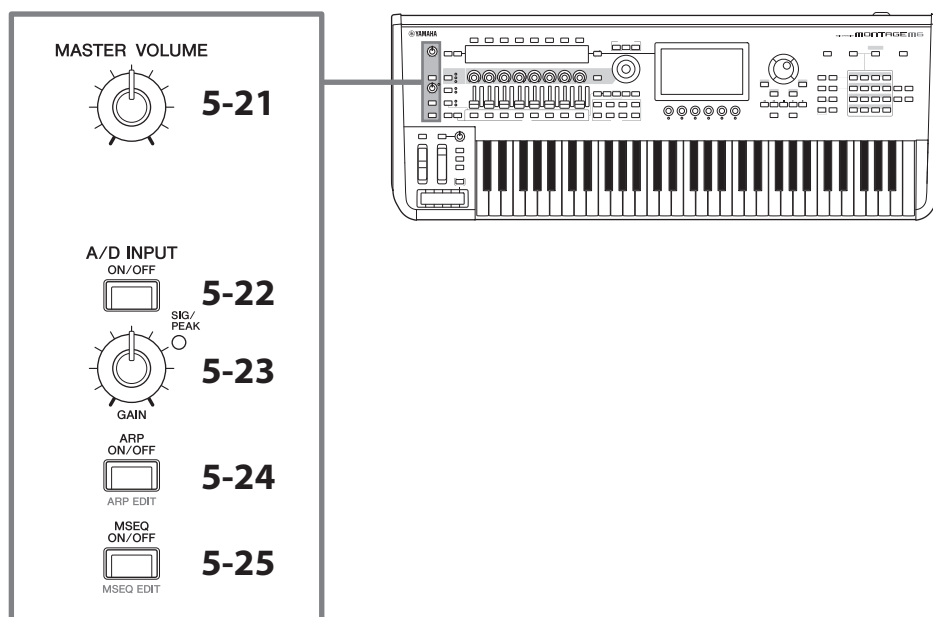

5-21 [MASTER VOLUME] knob

Use this knob for adjusting the Master volume.

5-22 [A/D INPUT ON/OFF] button

Use this button to enable or disable the inputs from the A/D INPUT jacks.

5-23 A/D INPUT [GAIN] knob

Use this knob to adjust the gain for the audio signals input from the A/D INPUT.

Whenever there is an input, the SIG/PEAK lamp is turned on in blue. When the input signal reaches just short of clipping, the SIG/PEAK lamp lights up in red. Adjust the knob so that the SIG/PEAK lamp briefly turns red whenever the input signal reaches the maximum level.

NOTE

You may need to change the gain setting depending on the level of the external equipment connected to the A/D INPUT jacks, in the following order: [UTILITY] → *Settings* → *Audio I/O* → *A/D Input*. When the output level of the connected equipment (such as a microphone) is low, set this parameter to *Mic*. When the output level of the connected equipment (such as a synthesizer keyboard or CD player) is high, set this parameter to *Line*.

For other input-related parameters, change the settings as shown below.

The Volume for the A/D Input block and send level for the Pan and effects

- [PERFORMANCE] → *Mixing*
- [EDIT/↶↷] → *Audio In* → *Mixing*
- [NAVIGATION] → [PART COMMON] → *A/D Input*
or
[PART COMMON] → [NAVIGATION] → *A/D Input*
- Set the Part group [1-8/9-16]/[USB AUDIO / A/D INPUT] button to "USB AUDIO / A/D INPUT," and then press PART button 8.

Destination for sending audio signals from the A/D INPUT jacks to the specific effect in the Effect block

- [EDIT/↶↷] → *Audio In* → *Routing*

Adjustment of the gain for the A/D INPUT jacks and enabling or disabling the jack

- A/D INPUT [GAIN] knob and A/D INPUT [ON/OFF] button
- [UTILITY] → *Settings* → *Audio I/O* → *A/D Input*

5-24 [ARP ON/OFF] button (ARP EDIT)

Use this button for enabling or disabling arpeggio playback.

The Arpeggio function lets you trigger rhythm patterns, riffs, and phrases using the current Part by simply playing notes on the keyboard.

It not only provides inspiration and full rhythmic passages in your live performances, but it gives you fully formed instrumental backing parts of various music genres for ease in creating songs.

If the Arpeggio switch for the Part is disabled, setting this button to ON will not playback the arpeggio for that Part.

Pressing this button while holding down the [SHIFT] button opens the screen for making Arpeggio settings (ARP EDIT screen).

5-25 [MSEQ ON/OFF] button (MSEQ EDIT)

Use this button to enable or disable the Motion Sequencer.

If the Motion Sequencer switch for the Part or the Lane is disabled, even setting this button to ON will not enable playback the Motion Sequence for that Part.

Pressing this button while holding down the [SHIFT] button opens the screen for making Motion Sequencer settings (MSEQ EDIT screen).

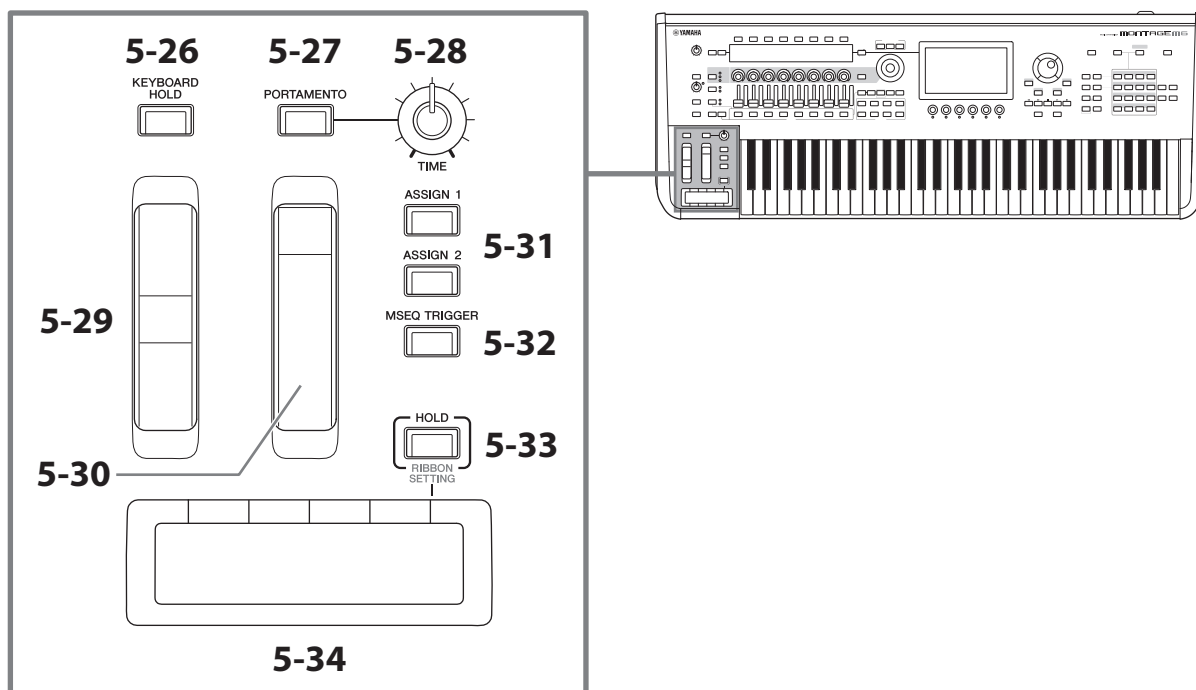

5-26 [KEYBOARD HOLD] button

When this button is turned ON, you can sustain the notes you play without using the sustain pedal. The use of sustain is automatically adjusted to prevent the end of the previous sustained note from blending with the notes of the next chord.

5-27 [PORTAMENTO] button

Use this button for setting the Portamento effect on and off.

Portamento is a function that creates a smooth transition in pitch from the first note played on the keyboard to the next.

5-28 PORTAMENTO [TIME] knob

Use this knob for adjusting the Portamento time.

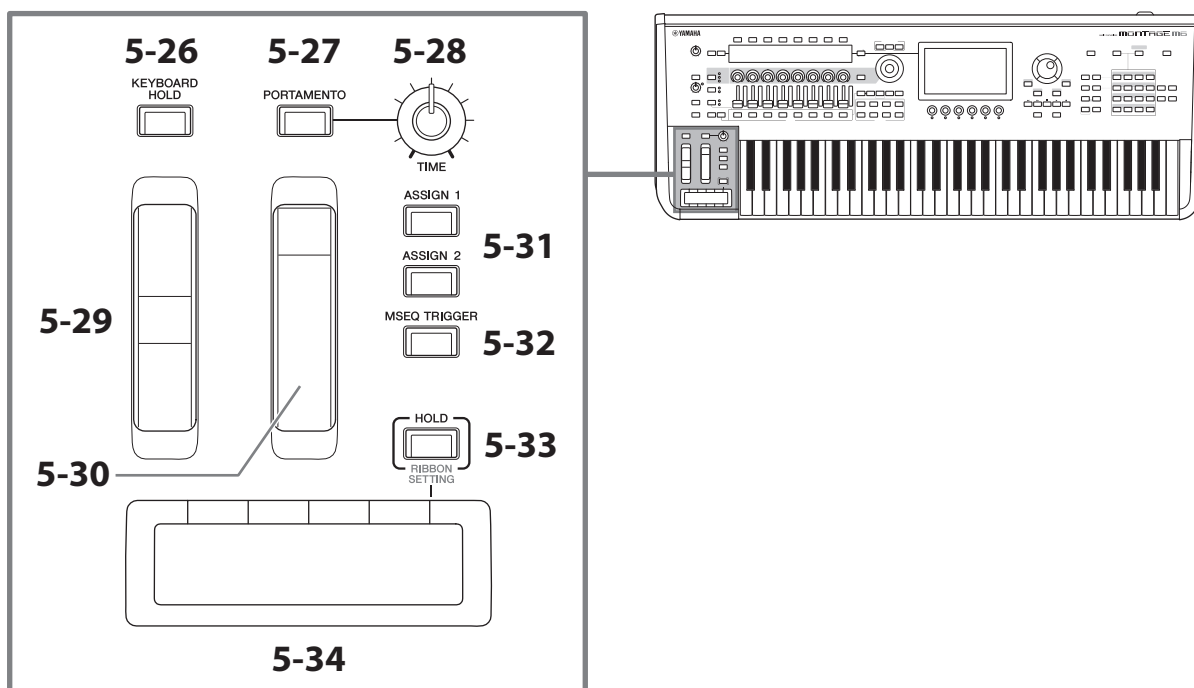

5-29 Pitch bend wheel

Use this wheel for controlling the pitch-bend effect.

The pitch bend range can be set from Part Edit → *Part Setting* → *Pitch*.

You can assign other functions for each Part, via Part Edit → *Mod/Control* → *Control Assign*.

5-30 Modulation wheel

You can assign functions individually to each Part, via Part Edit → *Mod/Control* → *Control Assign*.

5-31 [ASSIGN 1] and [ASSIGN 2] buttons

Use these buttons to control the elements and operators during your performance to create variations in sounds.

Other functions can be assigned as well.

To assign other functions individually to each Part, use Part Edit → *Mod/Control* → *Control Assign*.

To control elements that generate sounds by using the XA function, use Element Edit → *Osc/Tune* → *XA Control*.

You can set these buttons in two different ways. One is to keep the setting ON until the next time you press the button, and another is to keep the setting ON only while you are pressing the button. Select the settings via Common/Audio Edit → *General*.

5-32 [MSEQ TRIGGER] button

When the [MSEQ ON/OFF] button is ON or the *Motion SEQ Trigger* setting is ON, pressing this button plays back the motion sequence.

5-33 [HOLD] button (RIBBON SETTING)

Use this button for switching the Ribbon Controller settings.

Pressing this button while holding down the [SHIFT] button calls up the screen for making Ribbon Controller settings (RIBBON SETTING screen).

5-34 Ribbon controller

Use this controller by running your finger lightly across the surface laterally to control the specific parameter continuously. Or, you can have the parameter change in steps, depending on the setting. Depending on the function you've assigned, you can use it as a speed switch for the rotary speaker.

Playing the keyboard

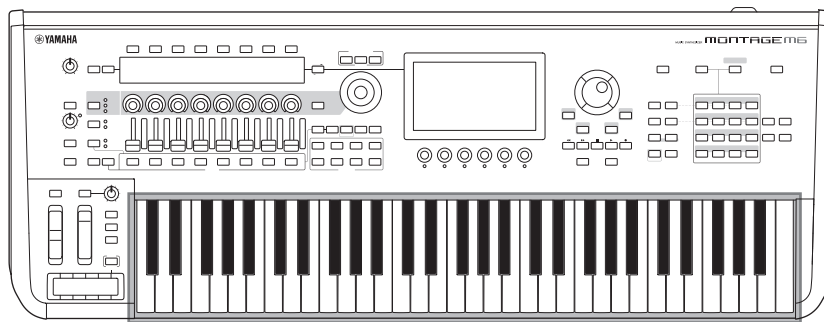

6 Keyboard

The MONTAGE M6 features a 61-key keyboard, while the MONTAGE M7 has 76 keys and the MONTAGE M8X has 88 keys. All are equipped with a touch response feature (both initial touch and aftertouch). With initial touch, the instrument senses how strongly or softly you play the keys and uses that playing strength to alter the sound in various ways, depending on the selected Performance. Aftertouch, on the other hand, lets you alter the sound by the amount of pressure you apply to a note after playing it. In addition, any of a variety of functions can be assigned to aftertouch for each Part.

The sophisticated GEX keyboard for the MONTAGE M8x provides exceptionally delicate expressiveness. Since the instrument has polyphonic aftertouch capability, you can control the aftertouch value individually for each key.

Rear panel

Connecting

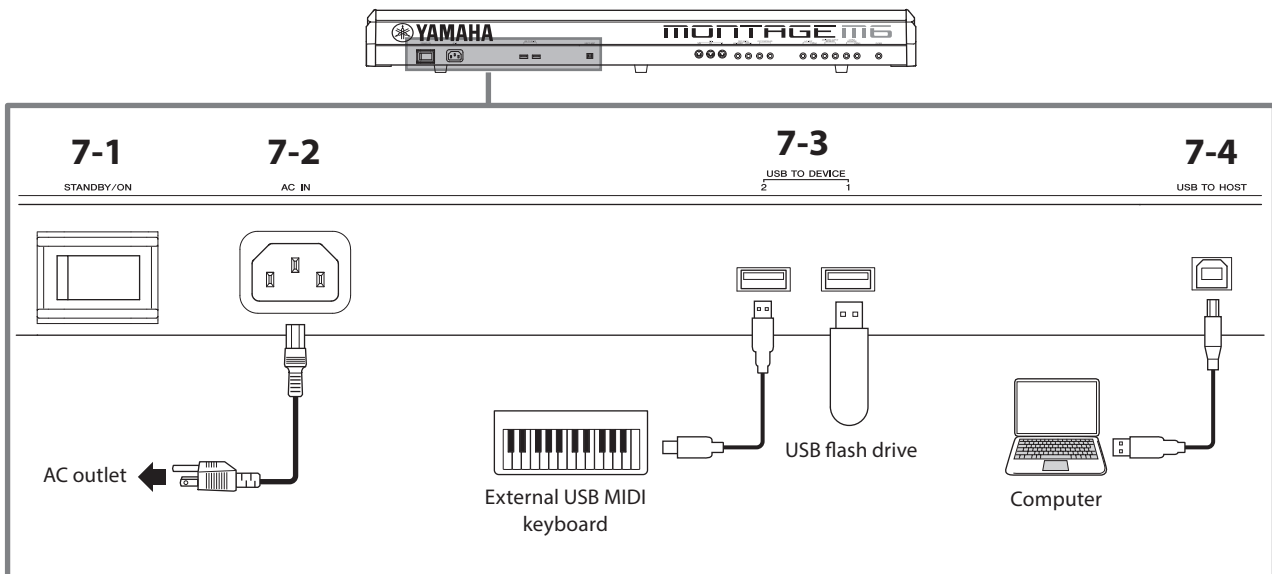

7-1 [STANDBY/ON] switch

Press this switch to set the instrument to On or Standby.

7-2 [AC IN] jack (power cord socket)

Connect the power cord supplied with this instrument.

7-3 USB TO DEVICE terminals

Use these terminals for connecting USB flash drives and USB MIDI keyboards.

When a USB flash drive is connected, the terminal lets you save data created on this instrument to the USB flash drive and load data from the USB flash drive to the instrument. Sending and receiving data between the USB flash drive and this instrument can be set from [UTILITY] → *Contents* → *Store/Save (or Load)*.

When a USB MIDI keyboard is connected, you can use it in the same way as the built-in keyboard of this instrument, as far as the connected keyboard's specifications allow. For more information, refer to the Operation Manual.

Precautions when using the USB TO DEVICE terminals

This instrument features built-in USB TO DEVICE terminals. When connecting a USB device to these terminals, be sure to handle the USB device with care. Follow the important precautions below.

NOTE

For more information about the handling of USB devices, refer to the owner's manual for the USB device.

■ Compatible USB devices

- USB flash drive
- USB MIDI keyboard

Other USB devices such as a USB hub, computer keyboard, or mouse cannot be used. The instrument does not necessarily support all commercially available USB devices. Yamaha cannot guarantee the operation of USB devices that you purchase.

Before purchasing a USB device for use with this instrument, please visit the following web page:

<https://download.yamaha.com/>

Although USB devices 1.1 to 3.0 can be used on this instrument, the amount of time for saving to or loading from the USB device may differ depending on the type of data or the status of the instrument.

NOTICE

The rating of the USB TO DEVICE terminal is a maximum of 5 V/500 mA for each terminal. Do not connect USB devices having a rating above this, since this can cause damage to the instrument itself.

■ Connecting a USB device

When connecting a USB device to the USB TO DEVICE terminal, make sure that the connector on the device is appropriate and that it is connected in the proper direction.

NOTICE

- Avoid connecting or disconnecting the USB device during playback/recording and file management operations (such as Save, Copy, Delete, and Format), or when accessing the USB device. Failure to observe this may result in "freezing" of the operation of the instrument or corruption of the USB device and the data.
- When connecting and then disconnecting the USB device (and vice versa), make sure to wait a few seconds between the two operations.
- Use an AB type USB cable of less than 3 meters.

7-4 [USB TO HOST] terminal

Use this terminal to connect a computer via a USB cable, allowing you to transfer MIDI data and audio data between the devices. Unlike MIDI, USB can handle multiple ports via a single cable. For information about how this instrument handles Ports, refer to the Operation Manual.

NOTE

Audio data sending capability for the instrument is a maximum of 32 channels (16 stereo channels) at a sampling frequency of 44.1 kHz or a maximum of 8 channels (4 stereo channels) for a sampling frequency of 44.1 kHz to 192 kHz. Audio data receiving capability is a maximum of 6 channels (3 stereo channels).

Precautions when using the [USB TO HOST] terminal

When connecting the computer to the [USB TO HOST] terminal, make sure to observe the following points to avoid freezing the computer/instrument and corrupting or losing the data.

NOTICE

- Use an AB-type USB cable.
- Execute the following before turning the power to the instrument on/off or plugging/unplugging the USB cable to/from the [USB TO HOST] terminal.
 - Quit any open application software on the computer.
 - Make sure that data is not being transmitted from the instrument. (Data is transmitted when the notes on the keyboard are played or a Song is played back.)
- While the computer is connected to the instrument, you should wait for six seconds or more between these operations: (1) when turning the power of the instrument off and then on again, or (2) when alternately connecting/disconnecting the USB cable.

If the computer or the instrument freezes, restart the application software or the computer OS or turn the power to the instrument off and then on again.

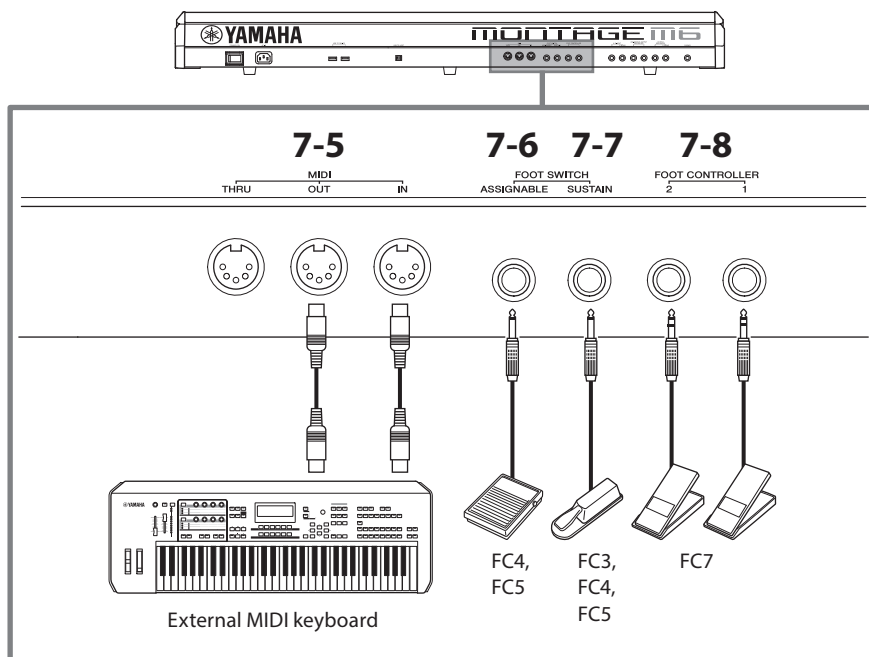

7-5 MIDI terminals

Use this terminal for connecting external MIDI devices.

7-6 FOOT SWITCH [ASSIGNABLE] jack

7-7 FOOT SWITCH [SUSTAIN] jack

Use these jacks for connecting footswitches and a sustain pedal.

FOOT SWITCH [SUSTAIN] is a jack for connecting separately sold foot switches FC3, FC4, and FC5 to use exclusively for sustain.

FOOT SWITCH [ASSIGNABLE] jack is a jack for connecting a separately sold FC4 and FC5 for using other functions you assign to the pedal. For example, you can use a footswitch to switch to the next Performance while the Live Set screen is shown.

NOTE



In this manual, the term "FC3" refers to the FC3 and all other equivalent products, such as the FC3A, and the term "FC4" refers to the FC4 and all other equivalent products, such as the FC4A.

7-8 FOOT CONTROLLER jacks

Use these jacks for connecting a separately sold FC7 Foot Controller.

You can assign a function in the Part Edit to control various parameters for the sound, such as its volume and pitch.

Jacks and pin alignment

Input and Output jacks	Polarities	Balanced/Unbalanced	Connector types
7-10 ASSIGNABLE OUTPUT (BALANCED) 7-11 OUTPUT (BALANCED)	Tip: Hot (+) Ring: Cold (-) Sleeve: Ground	Balanced	TRS phone plug Ring 
7-12 [PHONES]	Tip: L Ring: R Sleeve: Ground	—	
7-9 A/D INPUT	Tip: Signal Sleeve: Ground	Unbalanced	TS phone plug Sleeve Tip 

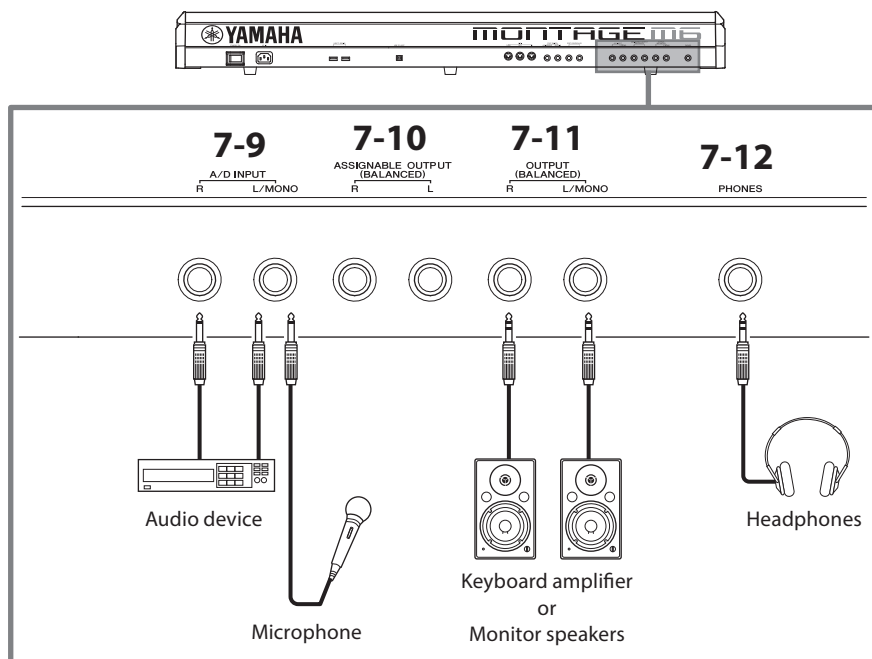

7-9 A/D INPUT jacks

Use these standard phone jacks for receiving the audio signals from the external device. By connecting an audio device such as a microphone and CD player, as well as another synthesizer and electronic musical instrument, you can play the sound as an audio input Part. Use the mono standard phone plug for connection. For stereo input using audio equipment, use the [L/MONO] and [R] jacks. For mono input using microphones, use only the [L/MONO] jack.

In addition, you can use the Vocoder as an internal effect with this instrument. When using the Vocoder, connect a microphone to the [L/MONO] jack and control the Vocoder by using the audio input from the microphone.

You can also use this jack for the Envelope Follower and ABS (Audio Beat Sync) features. For details about the Envelope Follower and ABS features, refer to the Operation Manual.

NOTE

- A guitar or bass having active pickups can be directly connected. However, when using passive pickups, connect the instrument via an effect device.
- The Vocoder/Envelope Follower can be controlled from all Part outputs and not just the A/D INPUT jack.

7-10 ASSIGNABLE OUTPUT (BALANCED) jacks (TRS balanced output)

Separate from the OUTPUT jacks, these TRS balanced output jacks are for outputting a specific sound or Part—allowing you to apply external effects or processing for that sound or Part. However, keep in mind that the System effect, Master effect, and Master EQ cannot be applied to the sound output from the ASSIGNABLE OUTPUT jacks. Listed below are the sounds or Parts that can be output individually.

- Drum Part keys to which drum/percussion instruments are assigned
- Metronome (Click)
- Any Part of a Performance*

* For more information on the audio input part (AUDIO IN Part), refer to the Operation Manual.

7-11 OUTPUT (BALANCED) jacks (TRS balanced output)

Use these TRS balanced output jacks for outputting the audio signals from this instrument. For mono outputs, use only the [L/MONO] jack.

7-12 [PHONES] (headphone) jack

Use this standard stereo phone jack for connecting a set of stereo headphones. This jack outputs audio signals identical to those from the OUTPUT jacks.

Setting up

Power supply

Connect the supplied power cord in the following order. Make sure the [STANDBY/ON] switch on the instrument is set to the Standby position.

1. Connect the supplied power cord to the AC IN terminal on the instrument's rear panel.
2. Connect the other end of the power cord to an AC outlet.



WARNING

Use only the power cord supplied with your instrument. The power cord supplied with your instrument must not be used with any other electrical devices. Failure to observe this precaution can result in the equipment being damaged, overheated or cause a fire.



WARNING

When setting up the product, make sure that the AC outlet you are using is easily accessible. If some trouble or malfunction occurs, immediately turn off the power switch and disconnect the plug from the outlet.

NOTE

Follow this procedure in reverse order when disconnecting the power cord.

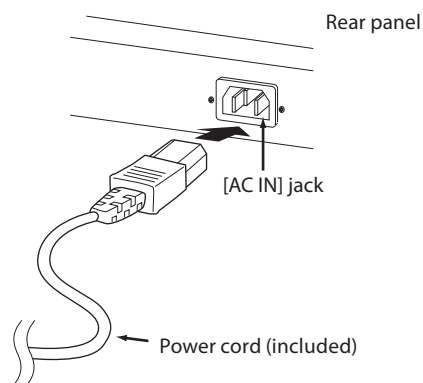

Connecting speakers or headphones

Since this instrument has no built-in speakers, you will need to monitor the sound of the instrument by using external equipment. Make sure to turn off any keyboard amplifiers, monitor speakers, and other devices, and then connect a set of headphones and any other devices as shown below. When making connections, be sure that your cables have the appropriate ratings.

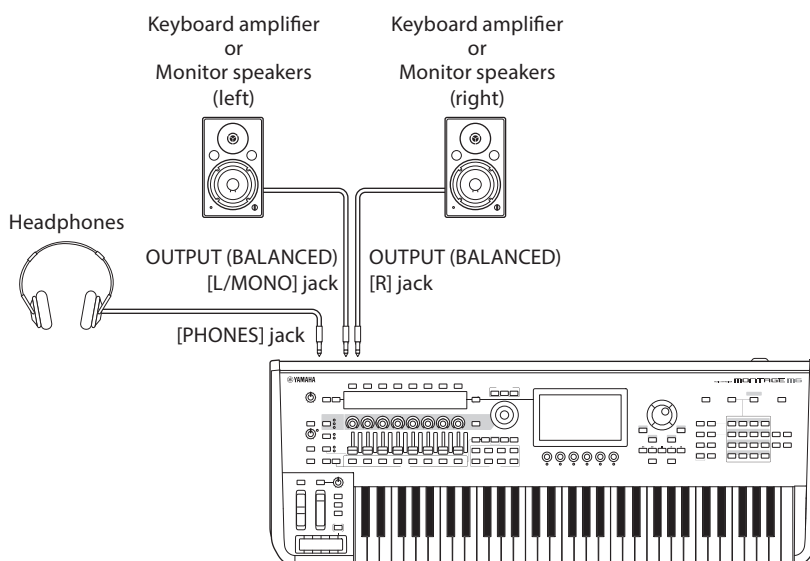

Turning the instrument ON

Turning the instrument OFF

Make sure the volume settings of the instrument and external devices, such as powered speakers, are turned to the minimum before turning the power on. When connecting the instrument to powered speakers, turn on the power switch of each device in the following order.

■ When turning the power on

First, the instrument (displays will turn on and buttons will light), and then the connected powered speakers.

■ When turning the power off

First, the connected powered speakers, and then the instrument (displays will turn off and buttons will turn off).

Keep in mind that the [STANDBY/ON] switch is located at the right side (from the view of the keyboard) of the AC IN socket on the rear panel of the instrument.



WARNING

Even when the [STANDBY/ON] switch is in standby status, electricity is still flowing to the product at the minimum level. Remove the electric plug from the outlet when the instrument is not to be used for extended periods of time, or during electrical storms.

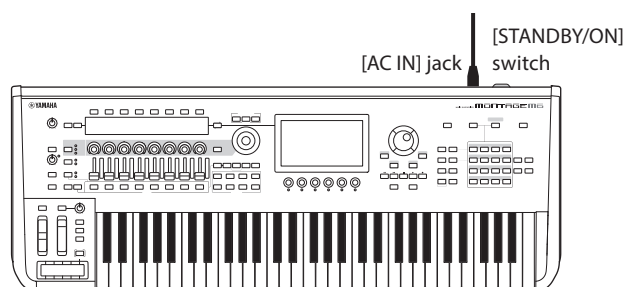

Auto Power Off function

To prevent unnecessary power consumption, this instrument features an Auto Power Off function that automatically turns the power off if the instrument is not operated for a specific period of time.

■ Auto Power Off setting

You can enable the Auto Power Off function and select the time setting for activating the function.

Procedure	[UTILITY] → Settings → Advanced → Auto Power Off
Settings (in minutes)	Off (Auto Power Off disabled), 5, 10, 15, 30, 60, 120
Default	Off (Auto Power Off disabled)

■ Disabling Auto Power Off (simple method)

Turn the power on while holding down the lowest key on the keyboard. An *Auto power off disabled* message appears briefly and Auto Power Off is disabled. The setting is retained even if the power is turned off.

NOTICE

The setting will revert to its default value if not backed up before the power is turned off.

- When the instrument is not operated for a specified period of time while connected to an external device such as an amplifier, speaker or computer, make sure to follow the instructions in this Quick Guide to turn off the power to the instrument and the connected devices in the proper sequence to protect the devices from damage. If you do not want the power to turn off automatically when a device is connected, disable Auto Power Off.
- When Auto Power Off is set to *off*, the value will be retained even if the backup data saved on another device is loaded to the instrument. When Auto Power Off is set to something other than *off*, the value will be overwritten with loaded data.

NOTE

- The setting time is approximate.
- To turn the power on after Auto Power Off has been carried out, press the [STANDBY/ON] switch.
- When the factory settings are restored, the setting time is changed to the default value (*off*).

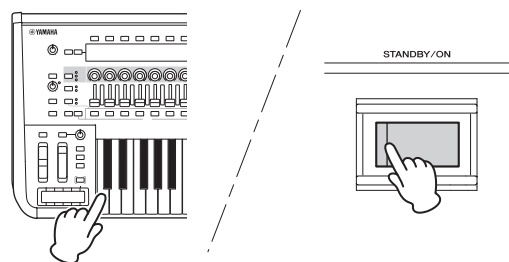

Adjusting the master volume

Adjust the overall level of this instrument by using the [MASTER VOLUME] knob.



CAUTION

Do not listen over the headphones at high volume for long periods of time. Doing so may cause hearing loss.

First, adjust the master volume on this instrument, and then other volume controls. For more information, refer to the Operation Manual.

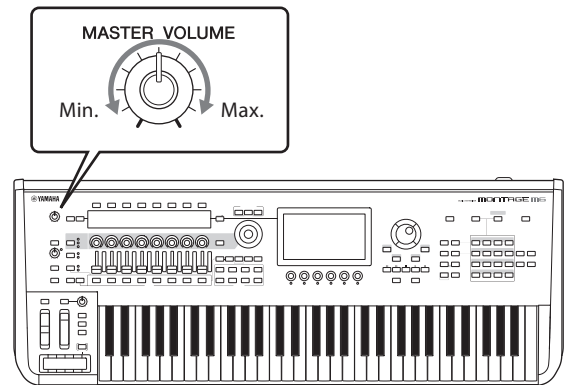

Panel Lock feature

Pressing this button while holding down the [SHIFT] button locks the operations on the controllers on the top panel. While Panel Lock is ON, any operations other than the built-in keyboard, pedals, master volume, super knob, pitch bend wheel, modulation wheel, ribbon controller, and the Panel Lock control itself will be disabled. The operations on the touchscreen will also be disabled.

Pressing this button again while holding down the [SHIFT] button unlocks the operations on the controllers on the top panel.

Using USB flash drives

By connecting a USB flash drive to a USB TO DEVICE terminal, you can save your custom data to the connected drive, as well as read data from it.

■ Number of USB flash drives that can be used

Up to two USB flash drives can be used.

■ Formatting a USB flash drive

You should format the USB flash drive only on this instrument. A USB flash drive formatted on another device may not operate properly.

NOTICE

The format operation overwrites any previously existing data. Make sure that the USB flash drive you are formatting does not contain important data. Proceed with caution, especially when connecting multiple USB flash drives.

NOTE

For more information on how to format the USB flash drive, refer to the Operation Manual.

■ To protect your data (write-protect)

To prevent important data from being inadvertently erased, enable write protection for the USB flash drive. If you are saving data to the USB flash drive, make sure to disable write protection.

■ Turning off the instrument

When turning off the instrument, make sure that the instrument is NOT accessing the USB flash drive by playback, recording or file management (such as during Save, Copy, Delete and Format operations). Failure to do so may corrupt the USB flash drive and the data.

Preparation for live performance

Shown below is a possible way for preparing the MONTAGE M for use in live performance situations.

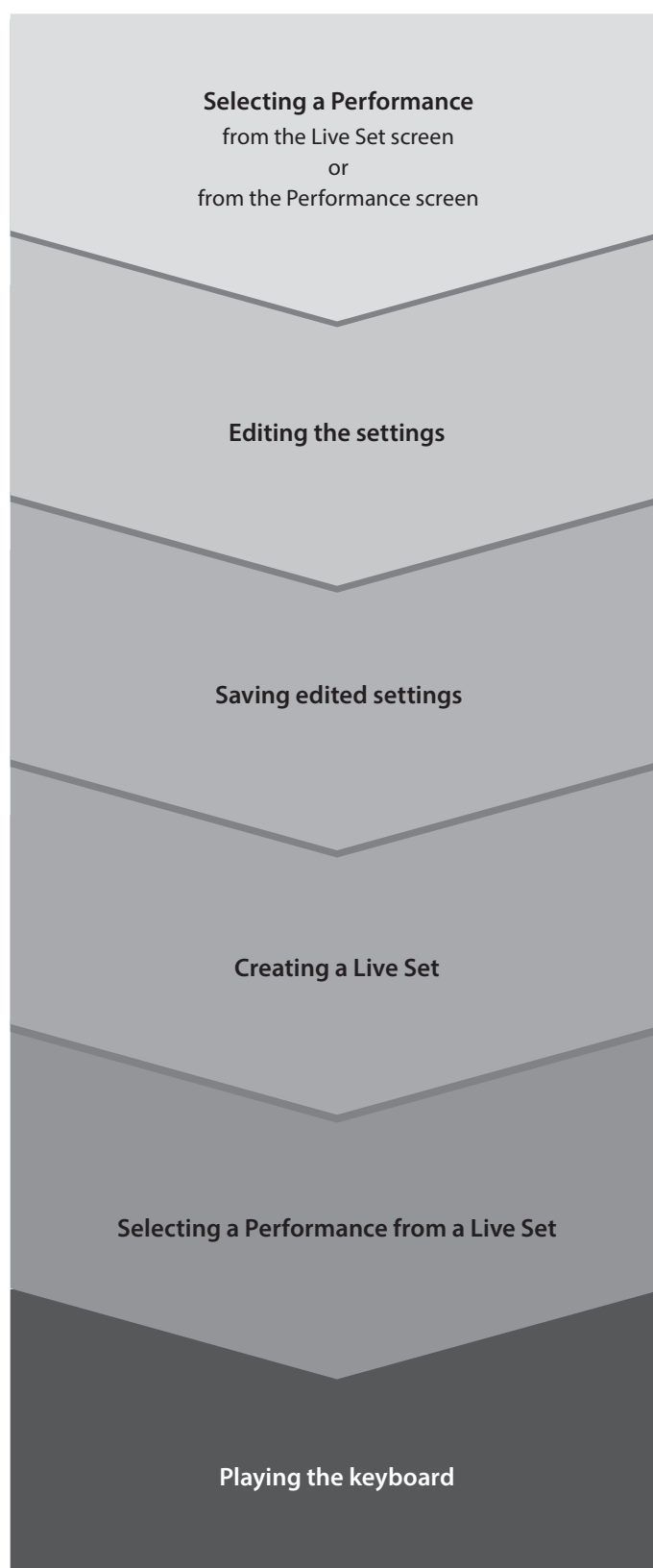

Status check and basic operation

You can check the status by looking at the buttons, sliders, and displays on the top panel. By using the data dial and buttons or by tapping the touchscreen, you can switch to a different screen or change settings.



Checking the status

Shown on the top panel

The brightness and the color of the buttons on the top panel indicate the status of the settings.

Brightness

There are three levels of brightness for the buttons.

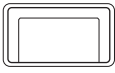
Brightness		Description
	Full light	The function is set to ON.
	Dim light	The function is available but set to OFF. You can press the button to set the function ON.
	Off	The function is not available and is set to OFF. Nothing occurs when you press the button.

Color

The color of the slider slits and buttons indicate what they are set to control.

Slider slits

Color		Controls
Bright blue	<i>Cyan</i>	<i>Internal Part</i>
Yellow	<i>Yellow</i>	Elements, drum keys, operators, oscillators
Red	<i>Red</i>	Audio
Blue	<i>Blue</i>	Parts in <i>External mode</i> or <i>DAW Remote mode</i>

Buttons

Color		Controls
Bright blue	<i>Cyan</i>	Live Set, Part select
Mint green	<i>Mint green</i>	Category Element, Operator, Oscillator select
Green	<i>Green</i>	Keyboard control
White	<i>White</i>	Real-time control
Magenta	<i>Magenta</i>	Solo or Mute
Red	<i>Red</i>	Others

Main display

Below are explanations of the Navigation bar shown on the Main display at all times.

Navigation bar

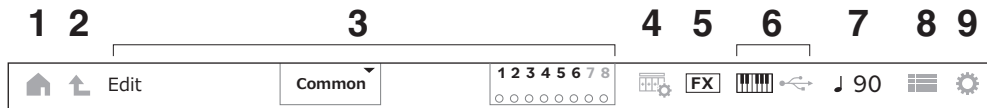

	Indicators		Descriptions
1		Home	The same function as the [PERFORMANCE] button on the top panel. Tapping the icon calls up the Performance screen (Home screen).
2		Exit	The same function as the [EXIT] button on the top panel. Tapping the icon returns one level up in the hierarchical order.
3		Information area	The current screen name and information regarding the Parts, elements, operators, oscillators, and drum keys. By tapping ▼, you can change the Part, element, operator, oscillator, and drum key.
	For Normal Parts		
			Status for the elements, operators, and oscillators are shown. <ul style="list-style-type: none"> • Mute: green "M" icon • Solo: red "S" icon
			Element numbers 1–8 The element being played is indicated by lights below the numbers. This is useful, for example, when specifying the velocity range for the element to play and checking to see if the element is being played.
			Operator numbers
			Oscillator numbers
	For Drum Parts		
		The status of the drum keys is shown. <ul style="list-style-type: none"> • The total number of drum keys set. • The green indicator is shown as the volume for the Drum Part being played. 	
4		View	For selecting a view for the Performance screen Tapping the icon calls up the list. You can press the [PERFORMANCE] button to switch to a different view.
5		Effects	The icon is turned off when an Insertion effect, System effect, or Master effect is turned off Tapping the icon calls up the Effect Switch screen.
6		Quick Setup	Local control on-off and MIDI IN and OUT settings Tapping the icon calls up the Quick Setup screen.
			Local control: on When turned off, the icon becomes dim.
			MIDI IN and MIDI OUT are set to MIDI
			MIDI IN and MIDI OUT are set to USB

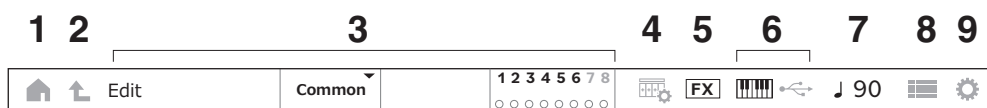

	Indicators		Descriptions
7	J 90	Tempo setting	Tempo for the current Performance Tapping the icon calls up the Tempo Setting screen.
8		Live Set	Tapping the icon calls up the Live Set screen.
9		Utility	Tapping the icon calls up the previous tab on the Utility screen.

Navigation button

The “map” of the signal flow of this instrument is shown on the screen. By tapping the item on the map you wish to edit, you can call up the corresponding setting screen.

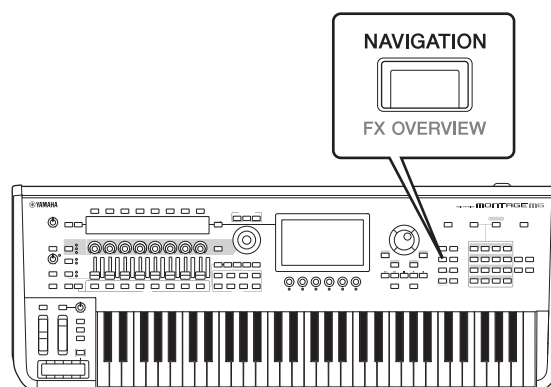

Performances and Parts

The Performances and the Parts are shown with flags and attributes.

Flags are labels that indicate the sound engine types for the Performance or the Part.

Flag	Descriptions
AWM2	Performance consisting only of AWM2 Parts; Part using AWM2.
(in 1 color)	Performance consisting only of FM-X Parts; Part using FM-X.
(in 2 colors)	Performance consisting only of FM-X Parts and Smart Morph; FM-X Part containing Smart Morph.
AN-X	Performance consisting only of AN-X Parts; Part using AN-X.

* The Performances that combine multiple sound engine types are expressed using the “+” sign.

Attributes are labels used to identify types of Performances or Parts. You can use the attribute to filter search results to see only the Performances or Parts that suit your needs.

Attribute	Descriptions
AWM2	AWM2 sound engine
FM-X	FM-X sound engine
AN-X	AN-X sound engine
MC	Performance that features Motion Control
SSS	Performance that supports <i>Seamless Sound Switching</i> <i>Seamless Sound Switching (SSS)</i> is a feature that lets you switch Performances smoothly without any notes being cut off. SSS is available under the conditions stated below. • Parts 9 to 16 are not used
<i>Smart Morph</i>	Performance with Smart Morph settings
<i>Single</i>	Single-Part Performance (Performance containing one Part) Use this when you want to play one instrument sound. The Single-Part Performances are shown in green on the Performance Category Search screen.
<i>Multi</i>	Multi-Part Performance (Performance containing multiple Parts) Use it this when you want to play multiple instruments in layer or split combinations. Multi-Part Performances are shown in blue on the Performance Category Search screen.
MOTIF XF	Factory Performance for MOTIF XF
MONTAGE	Factory Performance for MONTAGE
MONTAGE M	Factory Performance for MONTAGE M

Opening setting screens

When you select a tab on the first column from the left of the touchscreen, and then select a tab on the second column, the parameter edit view appears.

In the parameter edit view, you can change the parameter value or switch the settings on or off.

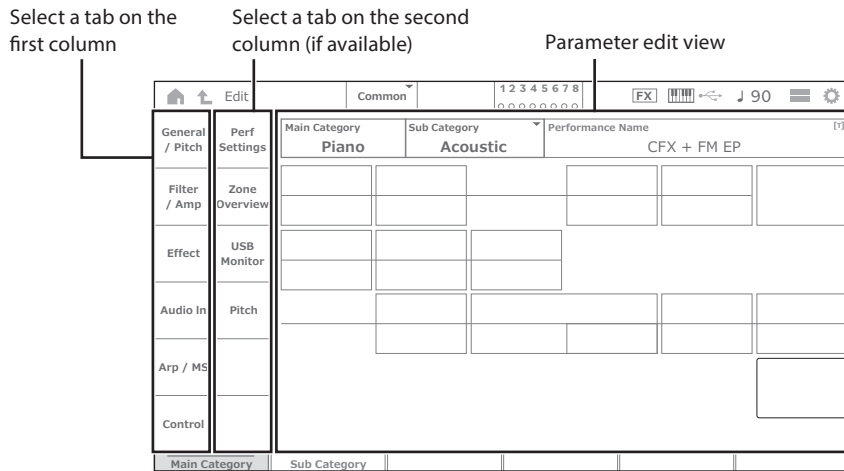

Close the edit view by doing one of the following:

- Press the [EXIT] button.
- Press the [ENTER] button.
- Tap the Home icon.
- Tap the Return icon.

Operation on the touchscreen is performed from left to right.

In the Operation shorthand, it is shown as: the button on the top panel (or the icon in the Navigation bar on the touchscreen) → tab on the first column → tab on the second column → the parameter edit view.

Example



You can use the buttons on the top panel or tap the touchscreen to call up the relevant screen.

By using the buttons

You can also select the desired tab by simultaneously holding down the [SHIFT] button and pressing the appropriate Category Select name/number button.

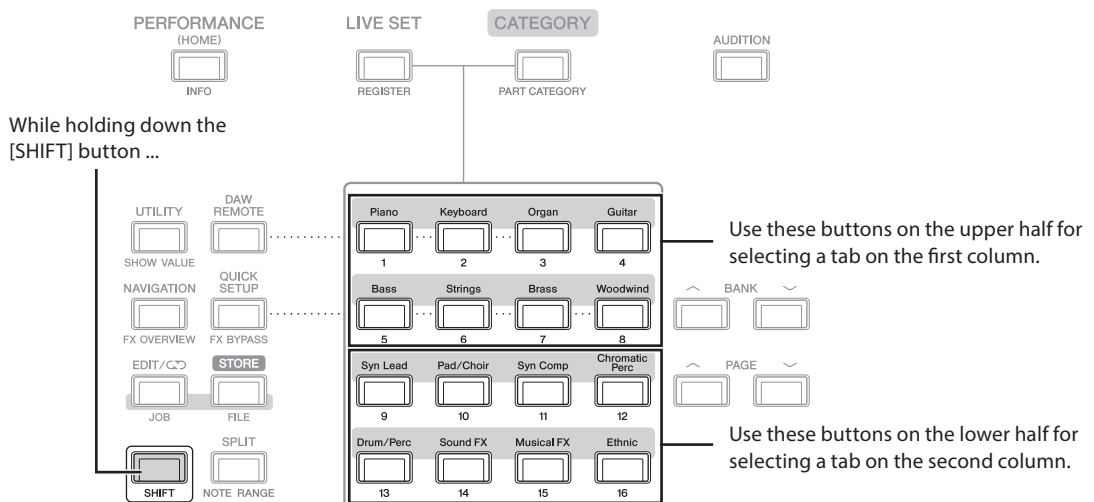

By using the touchscreen

Tap the appropriate tab shown on the touchscreen.

Moving the cursor and changing parameter values

Use the four cursor buttons on the dial ring to move the cursor on the touchscreen in four directions. You can move the cursor by touching the item shown on the touchscreen.

Change the parameter value at the cursor position by using the data dial, [INC/YES] button, and [DEC/NO] button.

For parameters with large value ranges, you can increase the value by 10 by holding down the [SHIFT] button and pressing the [INC/YES] button. To decrease by 10, hold down the [SHIFT] button and press the [DEC/NO] button.

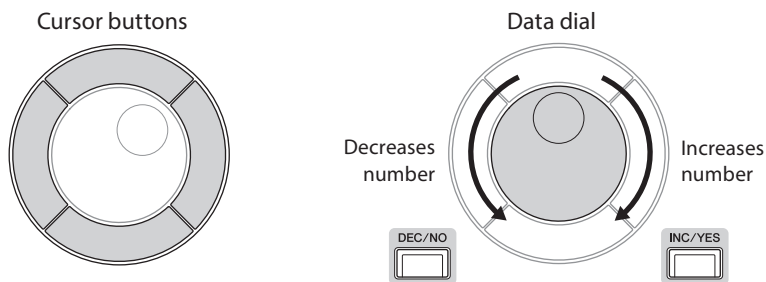



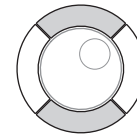
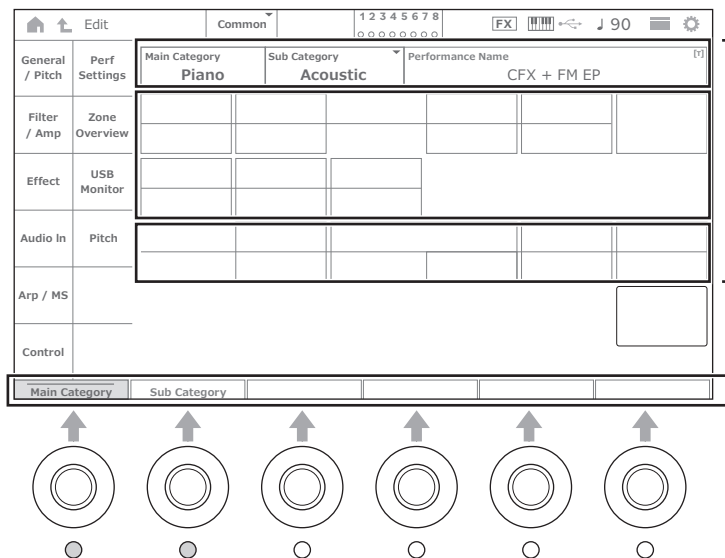



By moving a cursor position to a different row of the parameters using the up and down buttons, you can control a different set of parameters using the display knobs

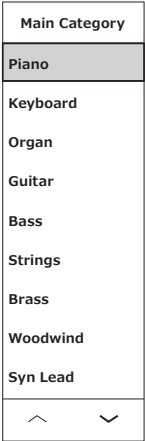

1. Move the cursor up and down to select a different row.

2. Use the display knobs to control the indicated parameters.

Icons shown for specific operations

Icons		Operations
	<p>The context menu appears.</p> 	<p>Tap the context menu button to switch to a different screen.</p>
	<p>The pop-up list appears.</p> <p>When there are many items, up and down scroll buttons are available.</p> 	<p>Touch the item that you wish to select from the list.</p> <p>To close the pop-up list, you can press the [ENTER] button or the [EXIT] button on the Top panel or tap outside the pop-up list on the screen.</p>
	<p>The screen for entering names appears.</p>	<p>Tap the icon to call up the screen for entering names.</p>
	<p>Move to a different screen</p>	<p>Tap the icon to call up the confirmation screen for the function. Use the [INC/YES] button or the [DEC/NO] button to confirm the operation.</p>
	<p>Add a Part</p>	<p>Tap the "+" sign to add a Part.</p>

Entering characters and numbers

Entering characters

To enter characters, use the keyboard shown on the screen.

The keyboard screen appears when you select the item that requires entering names by tapping the item on the screen or by moving the cursor to the item and pressing the [ENTER] button.

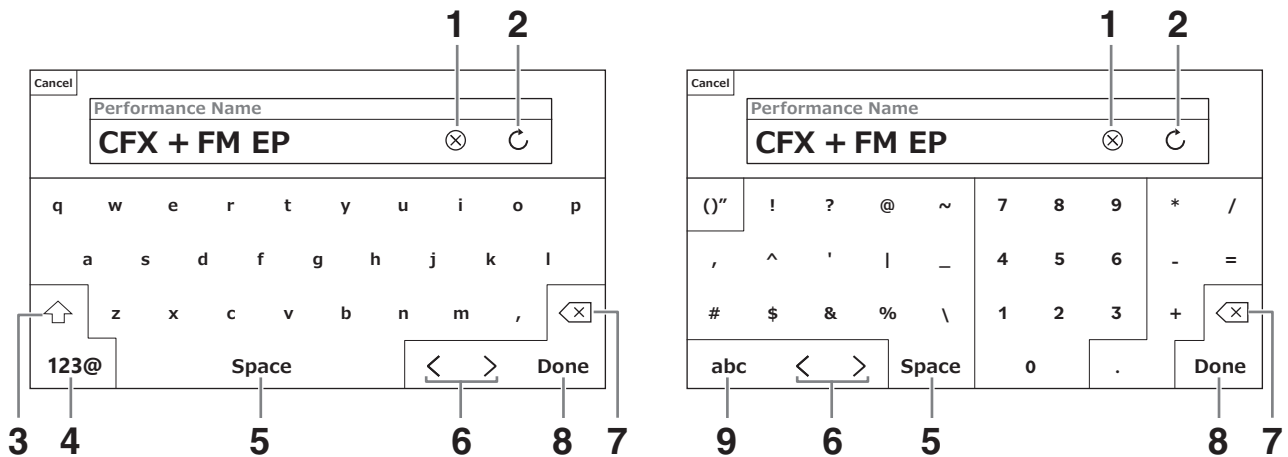

1	Delete all characters
2	Cancel all character changes on the screen
3	Switch between upper case and lower case
4	Switch to the keyboard for entering symbols
5	Insert a space at the cursor position (same as the [INC/YES] button)
6	Move the cursor
7	Delete one character (same as using the [DEC/NO] button)
8	Finish entering characters and close the screen
9	Switch to the keyboard for entering alphabetical characters

Entering numbers

For entering numbers, you can use the keys on the built-in keyboard or the numeric pad shown on the screen.

One way of entering a number is by pressing a key on the built-in keyboard. This is useful, for example, for entering a note number or velocity value.

Another way of entering a number is by using the numeric pad on the screen. This is useful, for example, for specifying the value that requires a numerical entry.

By tapping the corresponding item on the screen or by moving the cursor and pressing the [ENTER] button, the following tab appears.

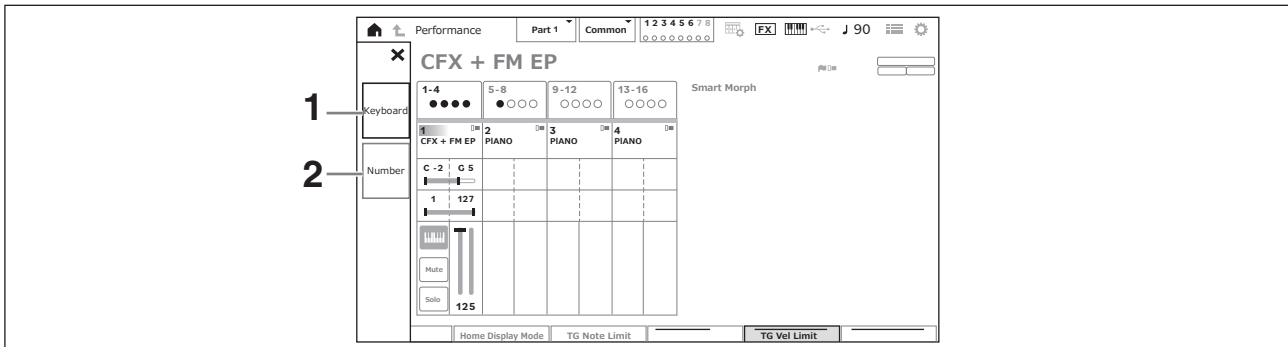

1	Enables keyboard entry Press a key on the built-in keyboard to enter the corresponding value for the note number or velocity.
2	Calls up the numeric pad screen Tap the numbers on the numeric keypad on the screen or use the Data dial, [INC/YES], and [DEC/NO] buttons to increase or decrease the value.

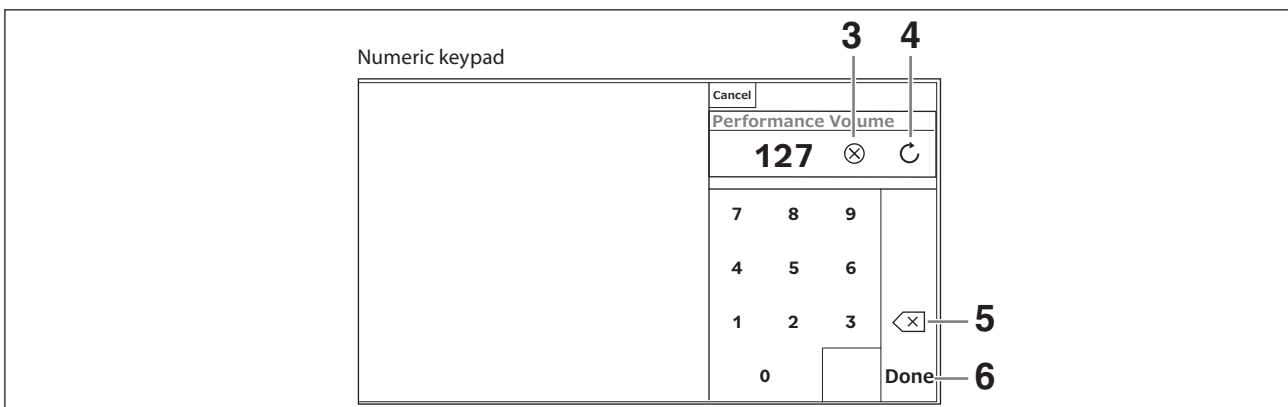

3	Deletes all numbers
4	Cancels the changes on the screen
5	Deletes the last digits
6	Finish entering numbers and close the screen

The Sub display

Using the Sub display

To change settings shown on the Sub display, use the [QUICK EDIT] button, Knobs 1 to 8, Tab selection buttons, Tab PAGE buttons, and the [ASSIGN] button.

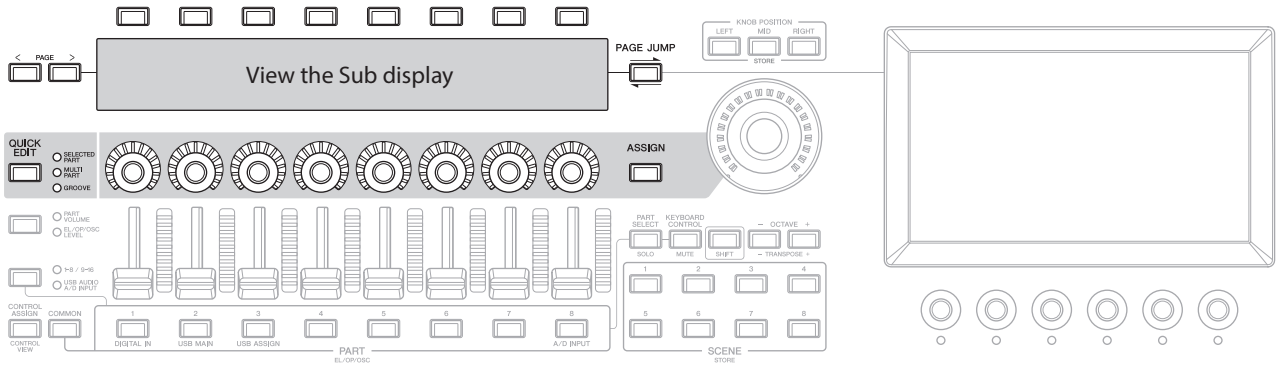

Using the Page Jump function

To change advanced settings of the parameters shown on the Sub display, use the [PAGE JUMP] button to move to the setting screen on the Main display and then edit the parameter value. After editing, press the [PAGE JUMP] button while holding down the [SHIFT] button so that the edited parameter values are shown on the Sub display.

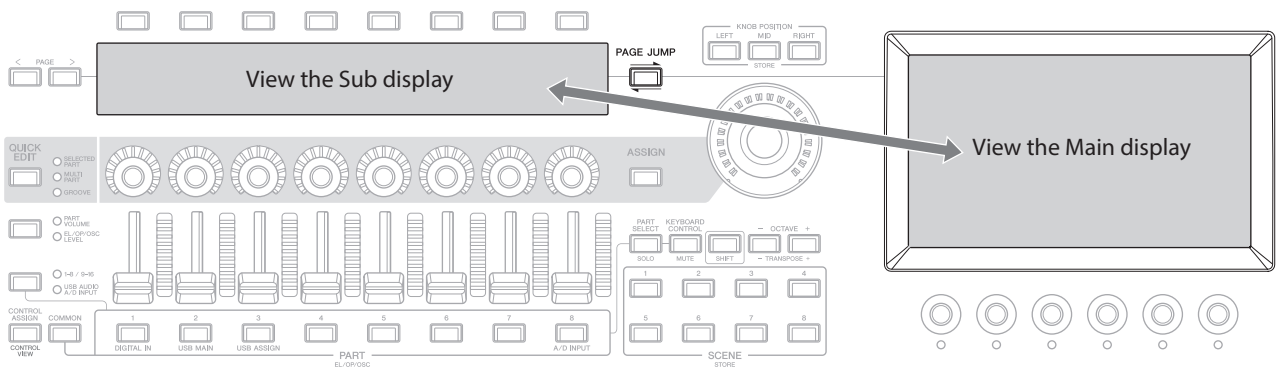

Playing the keyboard

First, select a preset Performance from the Live Set screen and try playing the keyboard.

Selecting a Performance from the Live Set screen

1. Press the [LIVE SET] button.

The Live Set screen appears.

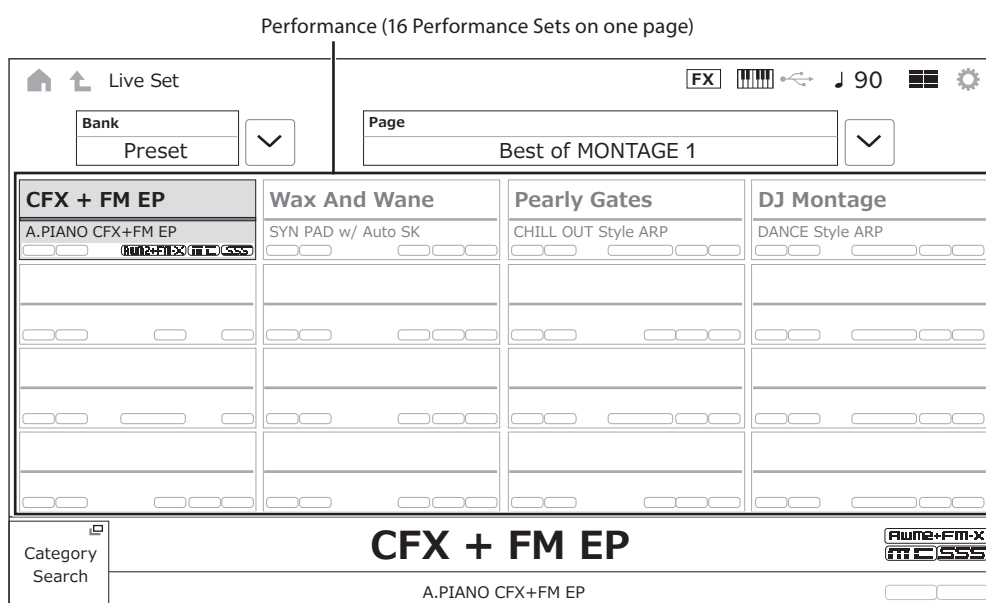

2. If necessary, press the [BANK] button and the [PAGE] button to select a different screen. Find a Performance you would like to use, and touch the Performance name on the screen to select it.

3. Play the keyboard.

You can also use the Performance screen to select a preset Performance and edit Performance settings. For more information, refer to the Operation Manual.

Troubleshooting

No sound? Wrong sound? When these or other problems occur, make sure to check the troubleshooting section in the Operation Manual before assuming that the product is faulty. Many problems can be solved by carrying out the *Initialize All Data* operation (below), after backing up your data to a USB flash drive. If the problem persists, consult your Yamaha dealer.

Restoring the factory default settings (*Initialize All Data*)

NOTICE

When the *Initialize All Data* function is carried out, all the Performances and songs in the User memory you have stored, as well as the Utility settings for the overall keyboard settings will be overwritten with their defaults. Make sure you are not overwriting any important data. Therefore, you should regularly save backups of important settings to a USB flash drive (refer to the Operation Manual).

1. Open the Settings screen from [UTILITY] → *Settings* → *System*.

This calls up the Settings screen for the entire instrument.

2. Tap *Initialize All Data*.

The confirmation screen appears.

To cancel the operation, tap the *Cancel No* button on the screen or press the [DEC/NO] button on the top panel.

3. Tap the *Yes* button on the screen or press the [INC/YES] button on the top panel.

The *Initialize All Data* operation is carried out.

Specifications

Keyboard	MONTAGE M8x: 88 keys, GEX Keyboard (Initial Touch/Polyphonic Aftertouch) MONTAGE M7: 76 keys, FSX Keyboard (Initial Touch/Aftertouch) MONTAGE M6: 61 keys, FSX Keyboard (Initial Touch/Aftertouch)
Tone Generator	Motion Control Synthesis Engine AMW2: 128 Elements (max.) FM-X: 8 Operators, 88 Algorithms AN-X: 3 Oscillators, 1 noise generator
Display	7" TFT Color Wide VGA LCD touchscreen, 512 × 64 full-dot LCD
Connectivity	USB TO DEVICE [1]/[2], [USB TO HOST], MIDI [IN]/[OUT]/[THRU], FOOT CONTROLLER [1]/[2], FOOT SWITCH [SUSTAIN]/[ASSIGNABLE], OUTPUT (BALANCED) [L/MONO]/[R] (6.3 mm, Balanced TRS jacks), ASSIGNABLE OUTPUT (BALANCED) [L]/[R] (6.3 mm, Balanced TRS jacks), [PHONES] (6.3 mm, standard stereo phone jack), A/D INPUT [L/MONO]/[R] (6.3 mm, standard phone jacks)
Dimensions, Weight	MONTAGE M8x: 1,446 (W) × 460 (D) × 170 (H) mm, 28.1 kg (56-15/16" (W) × 18-1/8" (D) × 6-11/16" (H), 61 lb 15 oz) MONTAGE M7: 1,244 (W) × 396 (D) × 131 (H) mm, 17.6 kg (49-0" (W) × 15-9/16" (D) × 5-3/16" (H), 38 lb 13 oz) MONTAGE M6: 1,037 (W) × 396 (D) × 131 (H) mm, 15.3 kg (40-13/16" (W) × 15-9/16" (D) × 5-3/16" (H), 33 lb 12 oz)
Included Accessories	Power cord, Quick Guide (this book), <i>Cubase AI download information</i> <i>Expanded Softsynth Plugin for MONTAGE M download information</i>

The complete list of specifications is available on the following website.

www.yamaha.com/2/montagem

* The contents of this manual apply to the latest specifications as of the publishing date. Since specifications, equipment or separately sold accessories may not be the same in every locale, please check with your Yamaha dealer.

Index

For a convenient index of terms on how to use the instrument, search the Operation Manual (HTML).
https://manual.yamaha.com/mi/synth/montage_m/index_q.html



A

AN-X	9, 36, 37
attribute	37
Auto Power Off function	31
AWM2	9, 36, 37

B

bank	11
------------	----

D

Drum Parts (AWM2)	10
-------------------------	----

E

Envelope Follower	9
-------------------------	---

F

factory default settings	45
flag	36
FM-X	9, 36, 37

G

GEX keyboard	25
--------------------	----

H

Hybrid sound engine	9
---------------------------	---

I

Init	10
------------	----

L

Library bank	11
Live Set	11

M

Motion Control	9, 10, 37
Motion Control Synthesis Engine	9
Motion Sequencer	9
Multi/GM	10
Multi-Part Performance	10, 37

N

Normal Parts (AN-X)	10
Normal Parts (AWM2)	10
Normal Parts (FM-X)	10

P

Panel Lock feature	32
Part	10
Performance	10
Preset bank	11

S

Single-Part Performance	10, 37
slot	11
Soundmondo	10
SSS	37
Super Knob	9

U

User bank	11
-----------------	----

V

Voice	10
-------------	----

Note on source code distribution

For three years after the final factory shipment, you may request from Yamaha the source code for any portions of the product which are licensed under the GNU General Public License or GNU Lesser General Public License by writing to the following address:

Digital Musical Instruments Strategy Planning Group, Digital Musical Instruments Development Department
Musical Instruments Business Unit, YAMAHA Corporation
10-1 Nakazawa-cho, Chuo-ku, Hamamatsu, 430-8650, JAPAN

The source code will be provided at no charge; however, we may require you to reimburse Yamaha for the cost of delivering the source code to you.

- Note that we shall bear no responsibility whatsoever for any damage arising from changes (additions/deletions) made to the software for this product by a third party other than Yamaha (or party authorized by Yamaha).
- Note that re-use of source code released to the public domain by Yamaha is unguaranteed, and Yamaha shall not bear any responsibility whatsoever for the source code.
- The source code can be downloaded from the following address:
<https://download.yamaha.com/sourcecodes/synth/>



Important Notice:

U.S. LIMITED WARRANTY for Customers in the United States

For detailed information about this Yamaha product and warranty service, please either visit the following website address (printable file is available at our website) or contact Customer Service at the address or telephone number identified below.

Website Address:

Yamaha.io/SynthAndStageWarranty

Customer Service:

Yamaha Corporation of America
6600 Orangethorpe Avenue, Buena Park, CA 90620-1273
Telephone: 800-854-1569

Important Notice: Guarantee Information for customers in European Economic Area (EEA) and Switzerland

Important Notice: Guarantee Information for customers in EEA* and Switzerland For detailed guarantee information about this Yamaha product, and Pan-EEA* and Switzerland warranty service, please either visit the website address below (Printable file is available at our website) or contact the Yamaha representative office for your country. * EEA: European Economic Area	English
Wichtiger Hinweis: Garantie-Information für Kunden in der EWR* und der Schweiz Für nähere Garantie-Information über dieses Produkt von Yamaha, sowie über den Pan-EWR*- und Schweizer Garantieservice, besuchen Sie bitte entweder die folgend angegebene Internetadresse (eine druckfähige Version befindet sich auch auf unserer Webseite), oder wenden Sie sich an den für Ihr Land zuständigen Yamaha-Vertrieb. *EWR: Europäischer Wirtschaftsraum	Deutsch
Remarque importante: informations de garantie pour les clients de l'EEE et la Suisse Pour des informations plus détaillées sur la garantie de ce produit Yamaha et sur le service de garantie applicable dans l'ensemble de l'EEE ainsi qu'en Suisse, consultez notre site Web à l'adresse ci-dessous (le fichier imprimable est disponible sur notre site Web) ou contactez directement Yamaha dans votre pays de résidence. * EEE : Espace Economique Européen	Français
Belangrijke mededeling: Garantie-informatie voor klanten in de EER* en Zwitserland Voor gedetailleerde garantie-informatie over dit Yamaha-product en de garantieservice in heel de EER* en Zwitserland, gaat u naar de onderstaande website (u vindt een afdrukbaar bestand op onze website) of neemt u contact op met de vertegenwoordiging van Yamaha in uw land. * EER: Europese Economische Ruimte	Nederlands
Aviso importante: información sobre la garantía para los clientes del EEE* y Suiza Para una información detallada sobre este producto Yamaha y sobre el soporte de garantía en la zona EEE* y Suiza, visite la dirección web que se incluye más abajo (la versión del archivo para imprimir esta disponible en nuestro sitio web) o póngase en contacto con el representante de Yamaha en su país. * EEE: Espacio Económico Europeo	Español
Avviso importante: informazioni sulla garanzia per i clienti residenti nell'EEA* e in Svizzera Per informazioni dettagliate sulla garanzia relativa a questo prodotto Yamaha e l'assistenza in garanzia nei paesi EEA* e in Svizzera, potete consultare il sito Web all'indirizzo riportato di seguito (è disponibile il file in formato stampabile) oppure contattare l'ufficio di rappresentanza locale della Yamaha. * EEA: Area Economica Europea	Italiano
Aviso importante: informações sobre as garantias para clientes da AEE* e da Suíça Para obter uma informação pormenorizada sobre este produto da Yamaha e sobre o serviço de garantia na AEE* e na Suíça, visite o site a seguir (o arquivo para impressão está disponível no nosso site) ou entre em contato com o escritório de representação da Yamaha no seu país. * AEE: Área Económica Europeia	Português
Σημαντική σημείωση: Πληροφορίες εγγύησης για τους πελάτες στον ΕΟΧ* και Ελλάδα Για λεπτομερείς πληροφορίες εγγύησης σχετικά με το παρόν προϊόν της Yamaha και την κάλυψη εγγύησης σε όλες τις χώρες του ΕΟΧ και την Ελλάδα, επισκεφτείτε την παρακάτω ιστοσελίδα (Εκτυπώσιμη μορφή είναι διαθέσιμη στην ιστοσελίδα μας) ή απευθυνθείτε στην αντιπροσωπεία της Yamaha στη χώρα σας. * ΕΟΧ: Ευρωπαϊκός Οικονομικός Χώρος	Ελληνικά
Viktigt: Garantiinformation för kunder i EES-området* och Schweiz För detaljerad information om denna Yamahaprodukt samt garantiservice i hela EES-området* och Schweiz kan du antingen besöka nedanstående webbadress (en utskriftsvänlig fil finns på webbplatsen) eller kontakta Yamahas officiella representant i ditt land. * EES: Europeiska Ekonomiska Samarbetsområdet	Svenska
Viktig merknad: Garantiinformasjon for kunder i EØS* og Sveits Detaljert garantiinformasjon om dette Yamaha-produktet og garantiservice for hele EØS-området* og Sveits kan fås enten ved å besøke nettstedene nedenfor (utskriftsversjon finnes på våre nettsider) eller kontakte Yamahas kontoret i landet der du bor. *EØS: Det europeiske økonomiske samarbeidsområdet	Norsk
Vigtig oplysning: Garantioplysninger til kunder i EØ* og Schweiz De kan finde detaljerede garantioplysninger om dette Yamaha-produkt og den fælles garantiserviceordning for EØ* (og Schweiz) ved at besøge det websted, der er angivet nedenfor (der findes en fil, som kan udskrives, på vores websted), eller ved at kontakte Yamahas nationale repræsentationskontor i det land, hvor De bor. * EØ: Det Europæiske Økonomiske Område	Dansk
Tärkeä ilmoitus: Takuutiedot Euroopan talousalueen (ETA)* ja Sveitsin asiakkaille Tämän Yamaha-tuotteen sekä ETA-alueen ja Sveitsin takuuta koskevat yksityiskohtaiset tiedot saatte alla olevasta nettiosoitteesta. (Tulostettava tiedosto saatavissa sivustollamme.) Voitte myös ottaa yhteyttä paikalliseen Yamaha-edustajaan. *ETA: Euroopan talousalue	Suomi
Ważne: Warunki gwarancyjne obowiązujące w EOG* i Szwajcarii Aby dowiedzieć się więcej na temat warunków gwarancyjnych tego produktu firmy Yamaha i serwisu gwarancyjnego w całym EOG* i Szwajcarii, należy odwiedzić wskazaną poniżej stronę internetową (Plik gotowy do wydruku znajduje się na naszej stronie internetowej) lub skontaktować się z przedstawicielstwem firmy Yamaha w swoim kraju. * EOG — Europejski Obszar Gospodarczy	Polski
Důležité oznámení: Záruční informace pro zákazníky v EHS* a ve Švýcarsku Podrobné záruční informace o tomto produktu Yamaha a záručním servisu v celém EHS* a ve Švýcarsku naleznete na níže uvedené webové adrese (soubor k tisku je dostupný na našich webových stránkách) nebo se můžete obrátit na zástupce firmy Yamaha ve své zemi. * EHS: Evropský hospodářský prostor	Česky
Fontos figyelemztetés: Garancia-információk az EGT* területén és Svájcban élő vásárlók számára A jelen Yamaha termékre vonatkozó részletes garancia-információk, valamint az EGT*-re és Svájcra kiterjedő garanciális szolgáltatás tekintetében keresse fel webhelyünket az alábbi címen (a webhelyen nyomtatható fájl is található), vagy pedig lépjen kapcsolatba az országában működő Yamaha képviselői irodával. * EGT: Európai Gazdasági Térség	Magyar
Oluline märkus: Garantiiteave Euroopa Majanduspiirkonna (EMP)* ja Šveitsi klientidele Täpsemat teabe saamiseks selle Yamaha toote garantii ning kogu Euroopa Majanduspiirkonna ja Šveitsi garantiiteeninduse kohta, külastage palun veebisaiti alljärgneval aadressil (meie saidil on saadaval printitav fail) või pöörduge Teie regiooni Yamaha esinduse poole. * EMP: Euroopa Majanduspiirkond	Eesti keel
Svarīgs paziņojums: garantijas informācija klientiem EEZ* un Šveicē Lai saņemtu detalizētu garantijas informāciju par šo Yamaha produktu, kā arī garantijas apkalpošanu EEZ* un Šveicē, lūdzmu, apmeklējiet zemāk norādīto tīmekļa vietnes adresi (tīmekļa vietnē ir pieejams drukājams fails) vai sazinieties ar jūsu valsti apkalpojošo Yamaha pārstāvniecību. * EEZ: Eiropas Ekonomikas zona	Latviešu
Dėmesio: informacija dėl garantijos pirkėjams EEE* ir Šveicarijoje Jei reikia išsamios informacijos apie šį „Yamaha“ produktą ir jo techninę priežiūrą visoje EEE* ir Šveicarijoje, apsilankykite mūsų svetainėje toliau nurodytu adresu (svetainėje yra spausdintinas failas) arba kreipkitės į „Yamaha“ atstovybę savo šaliai. *EEE – Europos ekonominė erdvė	Lietuvių kalba
Dôležité upozornenie: Informácie o záruke pre zákazníkov v EHP* a Švajčiarsku Podrobné informácie o záruke týkajúce sa tohto produktu od spoločnosti Yamaha a garančnom servise v EHP* a Švajčiarsku nájdete na webovej stránke uvedenej nižšie (na našej webovej stránke je k dispozícii súbor na tlač) alebo sa obráťte na zástupcu spoločnosti Yamaha vo svojej krajine. * EHP: Európsky hospodársky priestor	Slovenčina
Pomembno obvestilo: Informacije o garanciji za kupce v EGP* in Švici Za podrobnejše informacije o tem Yamahinem izdelku ter garancijskem servisu v celotnem EGP in Švici, obiščite spletno mesto, ki je navedeno spodaj (natisljiva datoteka je na voljo na našem spletnem mestu), ali se obrnite na Yamahinega predstavnika v svoji državi. * EGP: Evropski gospodarski prostor	Slovenščina
Важно съобщение: Информация за гаранцията за клиенти в ЕИП* и Швейцария За подробна информация за гаранцията за този продукт на Yamaha и гаранционното обслужване в паневропейската зона на ЕИП* и Швейцария или посетете посочения по-долу уеб сайт (на нашия уеб сайт има файл за печат), или се свържете с представителния офис на Yamaha във вашата страна. * ЕИП: Европейско икономическо пространство	Български език
Notificare importantă: Informații despre garanție pentru clienții din SEE* și Elveția Pentru informații detaliate privind acest produs Yamaha și serviciul de garanție Pan-SEE* și Elveția, vizitați site-ul la adresa de mai jos (fișierul imprimabil este disponibil pe site-ul nostru) sau contactați biroul reprezentanței Yamaha din țara dumneavoastră. * SEE: Spațiul Economic European	Limba română
Važna obavijest: Informacije o jamstvu za države EGP-a i Švicarske Za detaljne informacije o jamstvu za ovaj Yamahin proizvod te jamstvenom servisu za cijeli EGP i Švicarsku, molimo Vas da posjetite web-stranicu navedenu u nastavku ili kontaktirate ovlaštenog Yamahinog dobavljača u svojoj zemlji. * EGP: Europski gospodarski prostor	Hrvatski

<https://europe.yamaha.com/warranty/>

Yamaha Worldwide Representative Offices

English

For details on the product(s), contact your nearest Yamaha representative or the authorized distributor, found by accessing the 2D barcode below.

Deutsch

Wenden Sie sich für nähere Informationen zu Produkten an eine Yamaha-Vertretung oder einen autorisierten Händler in Ihrer Nähe. Diese finden Sie mithilfe des unten abgebildeten 2D-Strichodes.

Français

Pour obtenir des informations sur le ou les produits, contactez votre représentant ou revendeur agréé Yamaha le plus proche. Vous le trouverez à l'aide du code-barres 2D ci-dessous.

Español

Para ver información detallada sobre el producto, contacte con su representante o distribuidor autorizado Yamaha más cercano. Lo encontrará escaneando el siguiente código de barras 2D.

Português

Para mais informações sobre o(s) produto(s), fale com seu representante da Yamaha mais próximo ou com o distribuidor autorizado acessando o código de barras 2D abaixo.

Русский

Чтобы узнать подробнее о продукте (продуктах), свяжитесь с ближайшим представителем или авторизованным дистрибьютором Yamaha, воспользовавшись двухмерным штрихкодом ниже.

Bahasa Indonesia

Untuk detail produk, hubungi perwakilan Yamaha terdekat atau distributor resmi Anda dengan mengakses barcode 2D di bawah ini.

简体中文

如需有关产品的详细信息,请联系距您最近的 Yamaha 代表或授权经销商,可通过访问下方的二维码找到这些代表或经销商的信息。

繁體中文

如需產品的詳細資訊,請聯絡與您距離最近的 Yamaha 銷售代表或授權經銷商,您可以掃描下方的二維條碼查看相關聯絡資料。

한국어

제품에 대한 자세한 정보는 아래 2D 바코드에 액세스하여 가까운 Yamaha 담당 판매점 또는 공식 대리점에 문의하십시오.



https://manual.yamaha.com/dmi/address_list/

