

# Video Sound Collaboration System for Huddle Rooms

## CS-700

Video Conference System / Système de vidéoconférence

ビデオ会議システム / 视频会议系统

Operations Guide



Always update the firmware to the latest version.

Please refer to the user's manual that provides detailed information on how to use the product.

You can download the latest firmware and user's manual from the following website:

<https://uc.yamaha.com/products/video-sound-bar/huddle-room-system/>

© 2020 YAMAHA UNIFIED COMMUNICATIONS, INC. All rights reserved. No part of this document may be reproduced in any form or by any means without express written permission from Yamaha Unified Communications, Inc. Product specifications are subject to change without notice.

Yamaha CS-700 Installation and Operation Guide  
MN-CS700-202003-EN  
March 2020 (Rev 1.4)

## Online Resources

Resource	Website
Yamaha Unified Communications	<a href="http://uc.yamaha.com/">uc.yamaha.com/</a>
Yamaha CS 700	<a href="http://uc.yamaha.com/products/video-sound-bar/huddle-room-system/">uc.yamaha.com/products/video-sound-bar/huddle-room-system/</a>
Customer Support	<a href="http://uc.yamaha.com/support">uc.yamaha.com/support</a>

# Contents

- Online Resources ..... 3
- Contents ..... 4
- Introduction..... 8
- About this Manual ..... 8
  - Abbreviations ..... 8
  - Trademarks..... 8
- Getting Started ..... 9
  - Content and Component Overview..... 9
    - CS-700 Unit..... 9
- Installing the system ..... 12
  - Bracket installation ..... 12
  - Placing the CS-700 unit on the bracket ..... 13
  - Connecting the CS-700 ..... 13
  - Installing unit in Bracket..... 14
  - Secure unit ..... 14
- Setting up the system..... 15
  - Connecting the Power..... 15
  - Connecting to a Computer – USB 3.0 ..... 16
  - Select device..... 16
  - Connecting to an IP Network for System Management and SIP telephony. 17
  - Discovering IP Address ..... 17
  - Connecting Extension Microphone ..... 18
  - Using Cable Management ..... 18
  - Adjusting Vertical Camera Angle ..... 18
- User Interface ..... 20
  - CS-700 ..... 20
  - Web User Interface (Web-UI)..... 20
- Service Application..... 49
  - Installation & Configuration ..... 50

Using the Service Application .....	55
Camera Control Application .....	69
Installation & Configuration .....	69
Using the Camera Control Application.....	73
Dialer Application .....	74
Supported Tablets.....	74
Dialer application.....	74
Installing the dialer application .....	74
Dialer interface .....	75
Home screen .....	75
Main Menu.....	76
Contacts .....	77
Call History .....	78
Connection.....	79
Settings.....	79
Dialing and call control .....	80
Basic Operations.....	85
USB Connected Video Conferencing – BYOD (Bring Your Own Device) .....	85
USB Connected Video Conferencing – DIR (Device in Room) .....	85
Controlling the Video Image .....	85
Bluetooth Pairing and Activation .....	85
Aux-IN Audio Support .....	86
Configuring the CS-700.....	87
Configuring using the Web User Interface.....	87
Configuring using the Service Application.....	87
Configuring using a Provisioning Server, Option 66 .....	87
Configuring using a Provisioning Server, Option 150 .....	88
Provisioning file.....	89
Sample device configuration file.....	89
Provisioning file parameters (All Models).....	90
Using the Application Programming Interface (API) .....	105

USB API functions.....	105
Telnet / SSH interface .....	108
USB/Telnet/SSH CLI Commands.....	108
Upgrading the Device Firmware.....	129
Through the Web UI.....	129
Through the Service Application .....	129
From the Provisioning Server.....	129
Appendix .....	130
Session Control Functionality Details per Third Party Application .....	130
Using Windows Computers and MacOS computers.....	130
USB 3.0 Extension Cables.....	130
SNMP Support Details.....	131
SNMP MIB for the CS-700 .....	132
Dial Plan definition.....	135
Definition of modifiers .....	135
Examples .....	136
Optimize Windows for CS-700 Audio .....	137
Troubleshooting.....	138
Reboot.....	138
Restore Factory Defaults .....	138
Cannot Access Web UI.....	138
Lost Password .....	139
Low Camera Image Quality (Far-end video).....	139
Misaligned Camera Image (Far-end video).....	140
No Camera Image at Far-end.....	140
Technical Specifications .....	141
Date code.....	143
Limited Warranty and Limitation of Liability.....	144
Limited Warranty .....	144
Exclusions and Remedies.....	145
WARRANTY EXCLUSION.....	145

Limitation of Liability ..... 146  
Disclaimer..... 146  
Governing Laws..... 146  
Open Source Software ..... 147

## **Introduction**

Thank you for choosing the Yamaha CS-700 Video Sound Collaboration System. This Video Sound Collaboration System allows you to provision your Huddle Room or small multipurpose conference room for all forms of multimedia Unified Communications using popular video collaboration applications, as well as independent VOIP-based conference call support. With Yamaha CS-700 products, video and audio performance is optimized for the Huddle Room space to deliver class-leading performance, ensuring every word of the conversation is heard, and every visual nuance is captured.

The complete CS-700 family includes all of the following models

- CS-700AV – Audio/Video/Management Model
- CS-700SP – Audio/Video/SIP/Management Model

Where there is a difference in capabilities or configuration, the document will highlight that explicitly.

## **About this Manual**

### **Abbreviations**

In this manual, the product names are described as follows.

- Yamaha CS-700: the product
- Microsoft® Windows®: Windows
- macOS®: macOS
- Google® Play Store®: Play Store

### **Trademarks**

- Microsoft and Windows are registered trademarks of Microsoft Corporation in the United States and other countries.
- Mac and macOS are registered trademarks of Apple Inc.
- Chrome OS is a trademark or registered trademark of Google Inc.
- Bluetooth® is a registered trademark of the Bluetooth SIG and is used by Yamaha in accordance with a license agreement.
- NFC logo (N-Mark) is a trademark or registered trademark of NFC Forum, Inc.
- Google and Google Play Store are registered trademarks of Google, LLC



# Getting Started

## Content and Component Overview

Depending on the system you have purchased, you will find the following content in the box:

CS-700AV, CS-700SP
CS-700 Sound/Camera Unit
Wall Mounting Bracket
Region Specific Power Cord
Power Supply
Ethernet Cable
USB Cable
Instructions

## CS-700 Unit

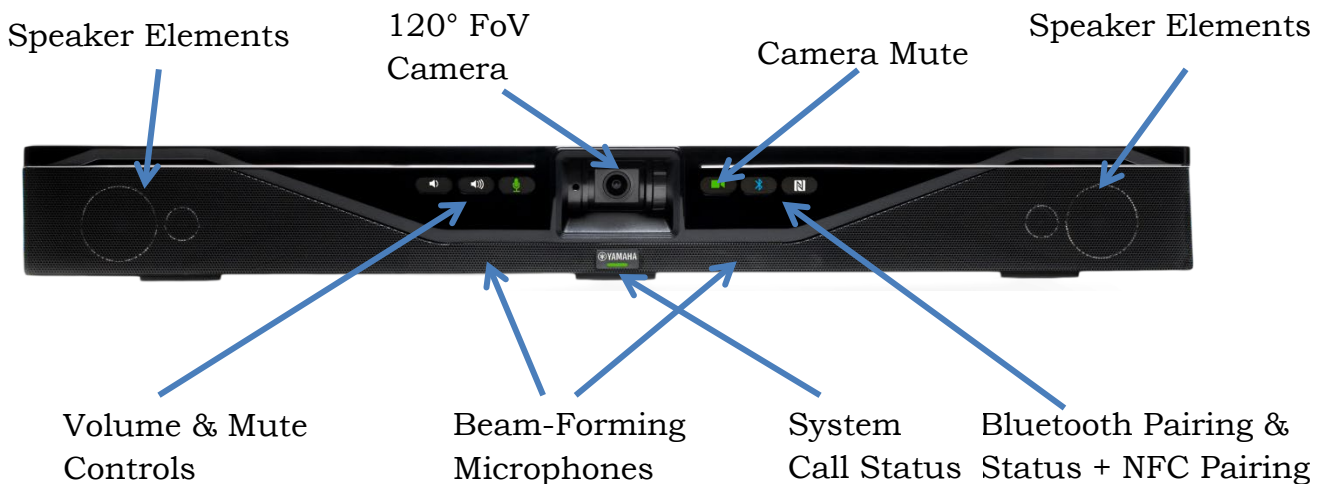

The main CS-700 Unit contains all the major components of the CS-700 System, including 4 Speaker Elements, 4 beam forming microphones, the optimized 120° FoV HD camera, and front-panel control buttons for: volume up/down, MIC mute, Camera mute, Bluetooth pairing, NFC Bluetooth pairing. A system status indicator shows state of the system.

### **Volume Control & Mute**

The speaker volume can be increased or decreased using the volume up and volume down buttons. The microphones are muted using the mute button. The mute/unmute button is only functional when microphones are activated.

The microphone mute button provides a colored indication of mute status. Three different microphone states correspond to the color of the LEDs.

<b>Speaker / Volume State</b>	<b>Volume LED Color</b>
Speaker Volume Buttons Enabled	White
Speaker Volume Buttons Not Enabled	OFF

<b>Microphone/Mute State</b>	<b>MIC LED Color</b>
Active microphones, unmuted	Green
Active microphones, muted	Red
Microphones not active	OFF

### **Camera Mute**

The camera can be “muted” to prevent active video transmission. Whenever the Camera Mute button is pressed to mute the video stream, the camera video stream is substituted with a “pause image” to the far-end.

The camera mute button provides a colored indication of the camera mute status. The button will light RED when pressed.

<b>Camera Streaming State</b>	<b>Camera MUTE LED Color</b>
Active camera, unmuted	Green
Active camera, muted	Red
Camera not active	White
Camera software upgrade in process	Slow Flash Red

### **Bluetooth Indicator and NFC Pairing**

The Bluetooth indicator shows whenever the CS-700 is in active pairing mode (flashing blue) or has actively connected with a local Bluetooth device (steady blue). The NFC pairing indicator enables Bluetooth devices capable of NFC pairing to do so with the CS-700.

<b>Bluetooth Pairing</b>	<b>Bluetooth LED Color</b>
Bluetooth Enabled, No Connection	White
Bluetooth Initializing	Slow Flash White
System Software Update In Process	Fast Flash White
Bluetooth Pairing In Process	Flash Blue
Bluetooth Enabled, Active Connection	Solid Blue
Bluetooth Service Not Enabled	OFF

<b>Bluetooth NFC Pairing</b>	<b>NFC LED Color</b>
Bluetooth Enabled + NFC Pairing Enabled	White
Bluetooth Service, NFC Not Enabled	OFF

***System Call Status Indicator***

The System Call Status Indicator located immediately below the Yamaha logo shows whenever the CS-700 is actively engaged in a call or not. It also shows whenever a hardware failure has been detected by turning RED. The following color codes have been assigned:

<b>Call Status Indicator</b>	<b>System Status LED Color</b>
Not in Call (BT, VOIP), or USB Connected but NO Video/Audio Stream	White
CS-700 Unit OFF or Booting-UP	OFF
Call Active (BT, VOIP), or USB Connected and Video/Audio stream active.	Green
Call on Hold	Flashing Green
Hardware Failure Detected	Red

## Installing the system

The CS-700 unit is designed to be mounted to the huddle-room wall using the bracket included with the unit. The recommended mounting location is directly adjacent to the display unit, typically just below it, with an optimal distance above the conference room table of 10-18 inches (25 – 45 cm). This provides an optimum camera perspective for the far-end.

If the CS-700 unit is used in conjunction with a touch-screen or electronic white board, the preferred installation location is immediately above the screen.

### Bracket installation

Install the bracket with 4 appropriate screws on the wall, spacing two pair of screws as far apart as possible. Ensure that the bracket is tight to the wall or the spacers to avoid vibration. If installed below the display ensure that the distance is big enough to fit the CS-700 unit. You can adjust the depth of the installation by using the appropriate number of spacers (0-2) on each side. Maximum mounting height is 2m / 6' 8" from the floor. Always use 4 screws.

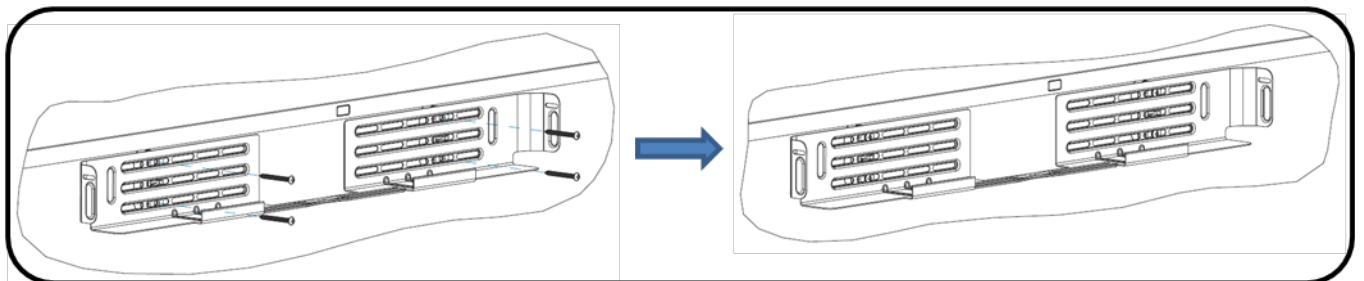
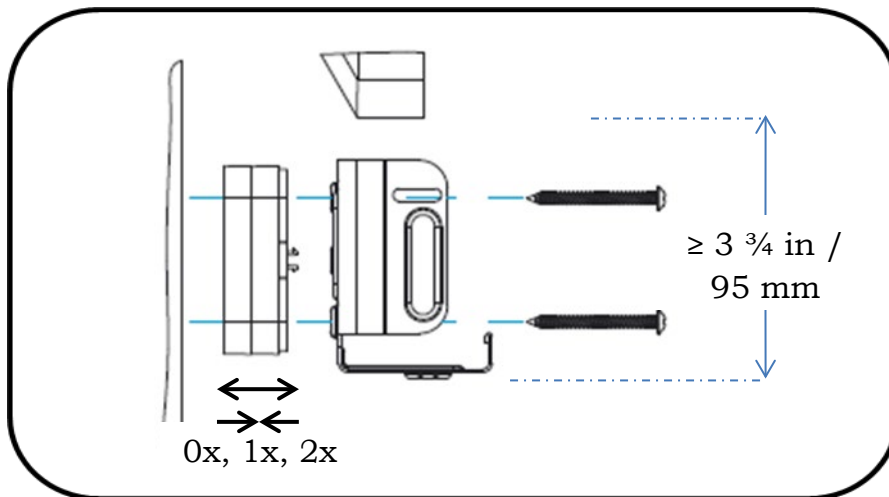

## Placing the CS-700 unit on the bracket

Position the CS-700 in such a way that the two hooks in the front of the bracket fit into the cavities on the lower part of the CS-700. Ensure that the CS-700 is safely held by the hooks.

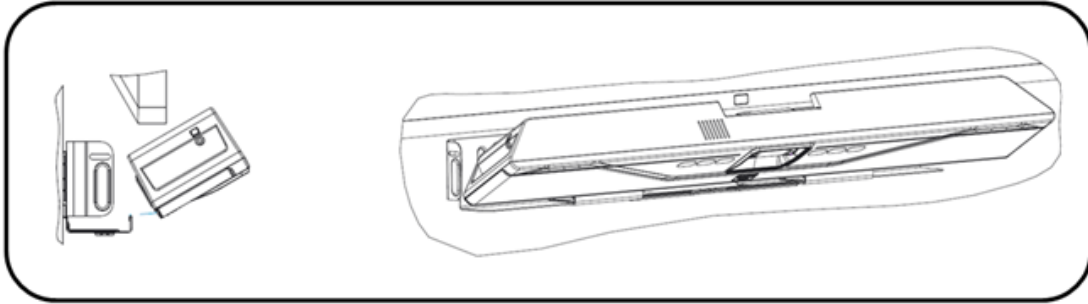

## Connecting the CS-700

Once the CS-700 is safely positioned on the hooks of the bracket, connect the power cable and the USB cable to the CS-700 as shown. If it is planned to manage the CS-700 using the web browser or as a SIP phone (-SP, -DS models), also connect the network cable into the corresponding connector. Secure the cables using the provided cable ties to the CS-700 unit.

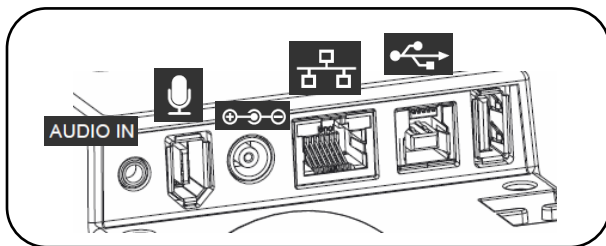
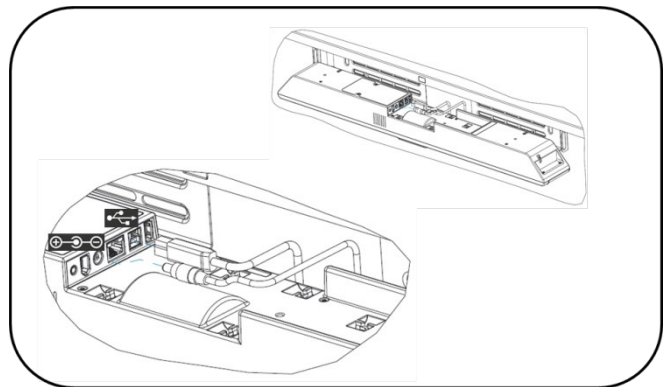
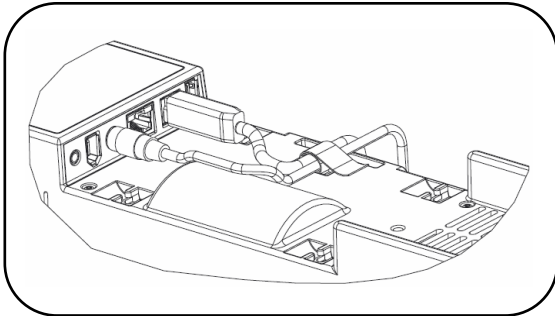

## Installing unit in Bracket

Once all cables are correctly connected and secured, tilt the CS-700 back on the bracket and push it pack into the bracket.

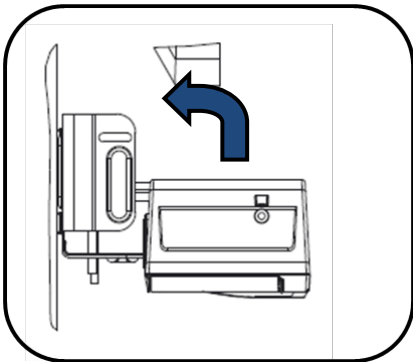
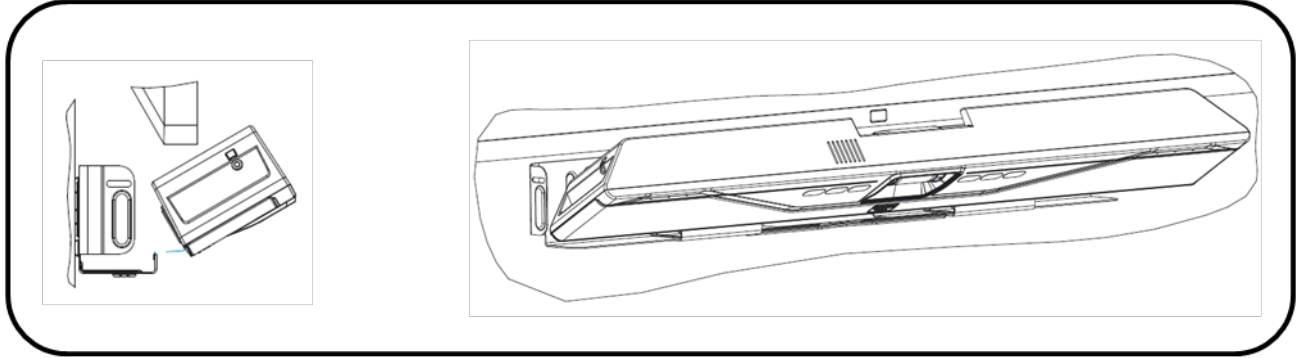

## Secure unit

Secure the CS-700 unit in the bracket with the provided machine screws.

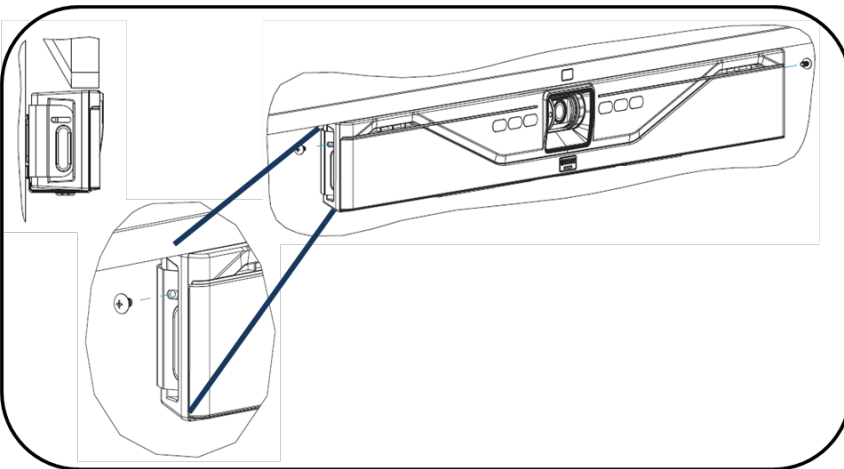

## Setting up the system

All connectors can be found on the back of the main CS-700 unit.

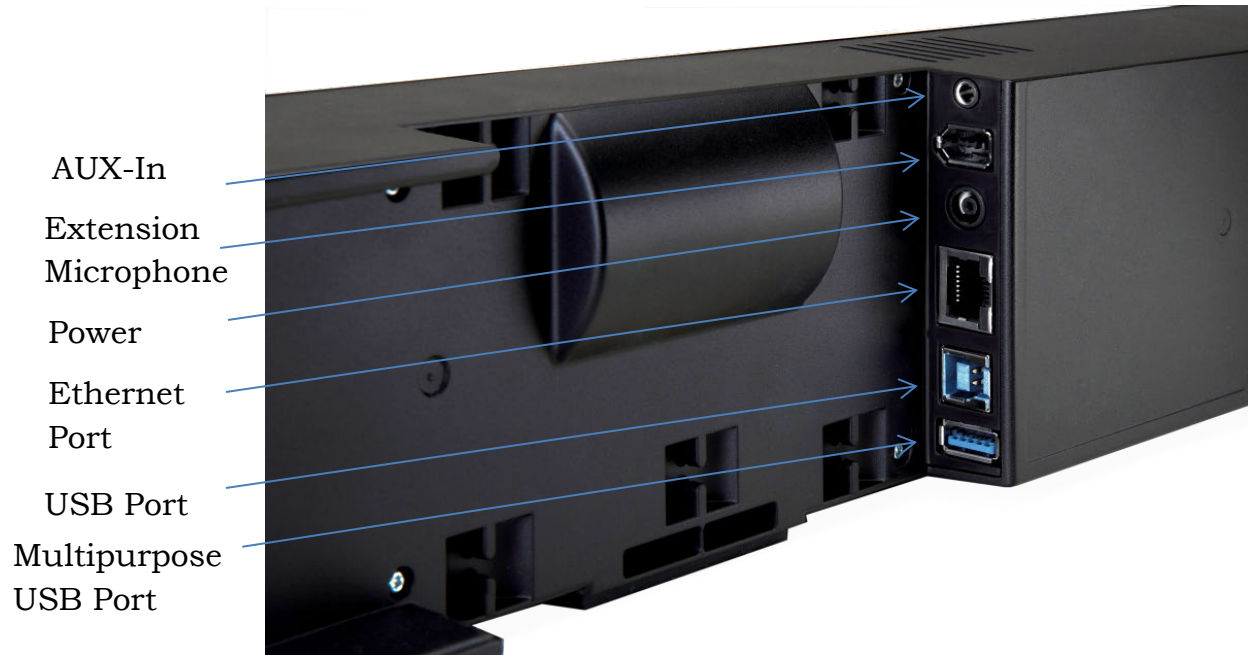

## Connecting the Power

Connect one end of the power supply cable into the Power Connector on the CS-700 back panel. Connect the other end of the Power Supply into your country-specific power extension cable, and connect the cable into the mains power. No power button is provided to ensure constant unit power; the CS-700 will immediately begin the boot-up sequence once the power connection is fully made.

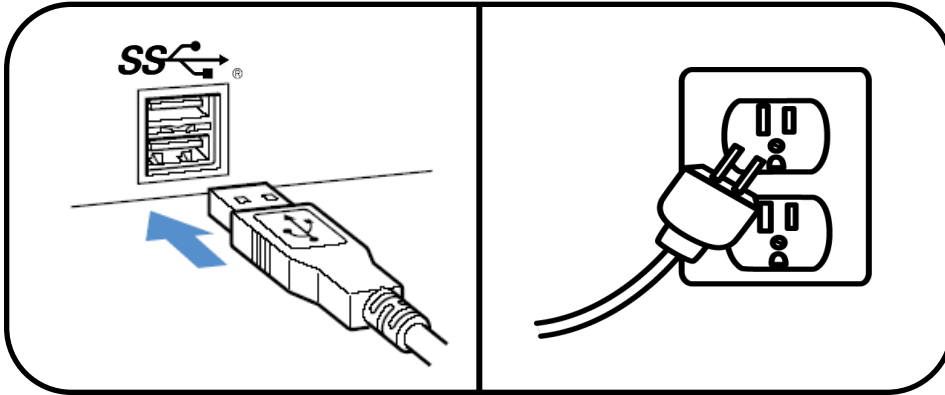

### **Connecting to a Computer – USB 3.0**

Using the included USB 3.0 cable, connect the USB Type-B side of the cable into the port identified by the icon on the back of the CS-700 unit.

Connect the other end of the cable to the USB 3.0 port on the computer running the third party softphone, webinar, or conferencing application. Connect the CS-700 USB cable directly into the attached PC device. If a USB 3.0 cable longer than the length of the one provided is required, please ensure that extension cables are fully USB 3.0 compliant and certified for video applications. Find a list of approved USB 3.0 extension cables in the appendix.

Be sure the PC USB Port supports USB 3.0. The camera of the CS-700 will send an uncompressed 1080p HD image over HD 3.0.

Note: The CS-700 will also support USB 2.0 connections with a reduced image resolution of 360p. If limited video quality is observed, verify that the USB port on the PC is truly 3.0.

When connecting to the Host computer, the Host OS may need to install pre-existing drivers provided with the operating system for use with the CS-700. Wait until the installation of such drivers has completed before continuing.

For optimal audio performance when using a Windows computer, please follow the instructions in the [appendix section](#). No additional configuration is required when using macOS or Chrome OS devices.

### **Select device**

In your operating system select the “Yamaha AudioVideo Device” as your default audio playback and recording device.



In your unified communications application, select the CS-700 as the Video device.

## **Connecting to an IP Network for System Management and SIP telephony**

Note, the CS-700 does not require a network connection in order to operate. The Plug-and-play nature of the USB connection is sufficient to enable the CS-700 to function. However, if any network management features, including network configuration, access to Web-UI, SNMP, and any SIP/VOIP connectivity (model CS-700SP) is required, an IP Network Connection is necessary.

Connect one end of the Ethernet cable into the network connection port on the bottom of the base unit using the network port. Press the Ethernet connector until it clicks into place. Connect the other end of the Ethernet cable into a jack providing network access. The CS-700 does not support being powered over PoE and requires power from the power supply.

If the Ethernet cable needs to be removed, depress the lever on the connector and pull the cable out gently. Using force when removing this cable may damage the cable and render it useless.

## **Discovering IP Address**

The IP Address is assigned to the CS-700 either by the DHCP protocol, or statically via the CS-700 configuration.

When using DHCP, the IP Address assigned to the CS-700 unit can be discovered three ways.

- Audible IP Address Reporting. Depress and hold the “Volume-UP” and “Bluetooth” buttons simultaneously for around 5 seconds. The CS-700 Unit will produce an audio-report of the currently assigned IP Address. If no address is assigned, the unit will reply “No address found”.

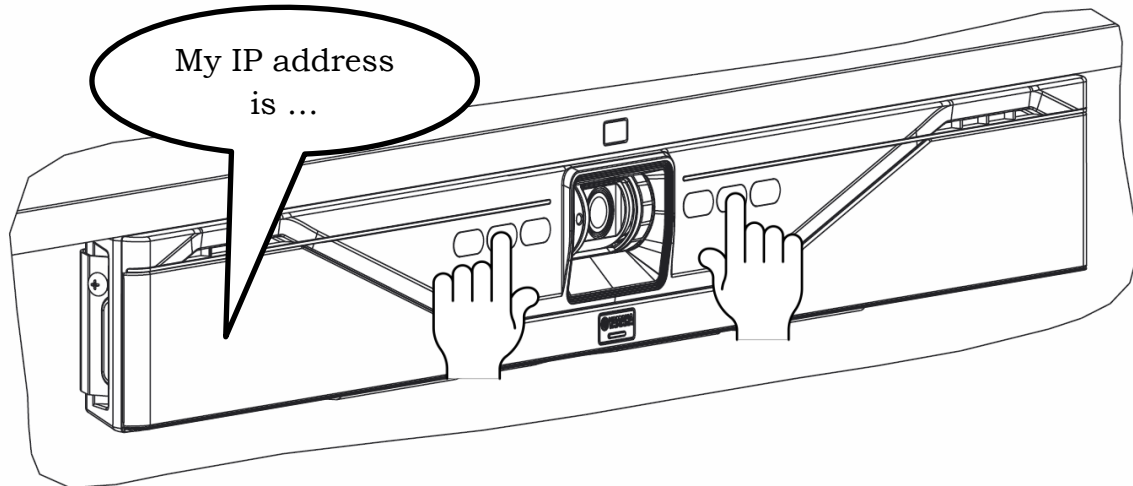

- Connected PC via USB Cable, operating the “Service Application”. The Service Application will provide a method of identifying the current IP and MAC addresses of the CS-700 unit. The Service Application is used by System Administrators.
- Interrogation of DHCP Server Leased IP Address List, and association with MAC Addresses. Known CS-700 MAC addresses will provide a remotely managed estate of CS-700 units to be mapped to IP Addresses.

### **Connecting Extension Microphone**

The CS-700 offers wired or wireless Extension Microphone to extend reach of microphone pick-up as an option. Connect the extension microphone into the CS-700 connector where indicated. Only the Yamaha extension microphone is qualified for operation on this port. The Wired Extension Microphone includes a 25-foot (7.50 meter) cable.

### **Using Cable Management**

To help secure the cables connected to the CS-700 main unit, indents are provided on the back casing to support the included “hook-and-loop” cable ties. Cables can be secured and tied-off on the back of the CS-700 to ensure robust cable connections.

### **Adjusting Vertical Camera Angle**

The CS-700 offers a manual vertical camera angle adjustment. This adjustment is performed just once during initial unit installation, to properly align the camera field of view with the table-top and conference participants. The adjustment is made using a small/medium screwdriver inserted and pressed into the adjustment hole on the left-side of the camera, then rotate the camera

assembly up or down to the desired angle. As the camera rotates, mechanical detents within the camera mechanism will lock the camera into position. You will hear clicking sounds as the detents engage.

**Important Note** - When adjusting the manual vertical camera angle do not force or over stress the mechanism as this could damage the camera mechanism. The mechanism will stop when it reaches the maximum adjustment, do not apply force beyond the maximum adjustment. Damage to the camera mechanism caused by excessive manual force will void warranty.



Camera Angle Adjustment

### ***Procedure for camera angle adjustment***

1. Connect a PC through the CS-700 USB cable, and enable UC software, a local PC camera application, or the Service Application.
2. Engage the UC Software / PC application / Service Application to display the CS-700 camera onto the local PC screen. This provides immediate feedback as to how the room appears on the far-side of a video conference.
3. Engage the Camera Vertical Angle Adjustment as described above to achieve a well-aligned capture of meeting room participants around the table. Alignment should balance participants in the middle of the video shot.

Note: The camera angle is adjusted simply by rotating the camera assembly up or down using the screwdriver shaft as a lever – there is no actual screw to adjust.

## **User Interface**

### **CS-700**

The CS-700 unit provides volume up, volume down, audio mute, camera mute, Bluetooth Pairing and Bluetooth NFC controls and indicators on the front of the unit.

Volume Up/Down buttons affect the sound from the CS-700, with corresponding increasingly or decreasingly loud “beeps” occurring with each press.

The CS-700 will default the sound level to a pre-set value following each new USB connection session.

Mute status is reflected on the color of the Mute Buttons.

- Audio microphone Mute not-enabled is green, while enabled is red. The button will be OFF whenever the button is disabled as a configuration option.
- Camera Mute not-enabled is green, while enabled is red. The button will glow white whenever the Camera is not active, and will be OFF whenever the button is disabled as a configuration option.

CS-700 front panel audio controls (Volume, Mute) are synchronized with audio controls on the attached Computer Operating System, enabling control from both locations. See the section “Session Control Functionality Details” in the appendix for more information.

### **Web User Interface (Web-UI)**

The CS-700 supports an internal webserver and web-based user interface (i.e. Web-UI), providing configuration and operations access to the unit using a standard web browser. This interface is intended for use by System Administrators, not end-users, and is only available through the IP network interface. Using the IP address of the CS-700, the Web-UI can be accessed using a web browser by entering the IP address in the URL line. Supported browsers are Microsoft Edge, Google Chrome, and Mozilla Firefox.

When accessing the CS-700 Web-UI webserver, the login page will be displayed. A password is required to log in to the device. Unless the password was previously changed, the factory default password is 7386.

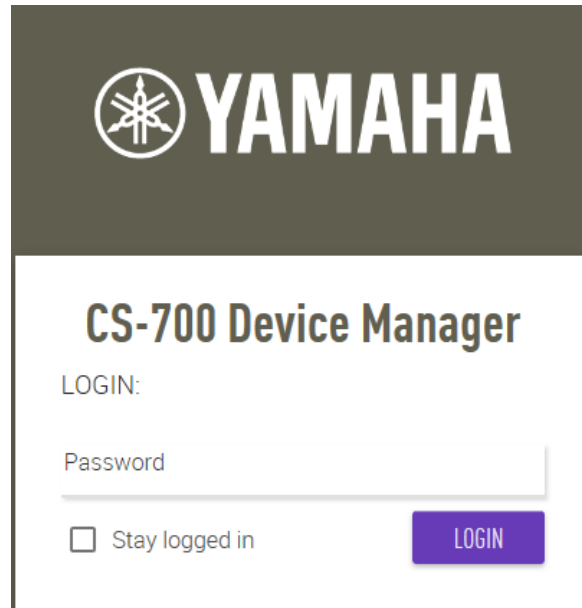

The image shows a login page for the Yamaha CS-700 Device Manager. At the top, there is a dark grey header with the Yamaha logo (a three-pronged tuning fork inside a circle) and the word "YAMAHA" in white, bold, uppercase letters. Below the header, the page has a white background. The title "CS-700 Device Manager" is displayed in a bold, dark grey font. Underneath the title, the word "LOGIN:" is followed by a text input field labeled "Password". Below the password field, there is a checkbox labeled "Stay logged in" and a purple button with the word "LOGIN" in white, uppercase letters.

Generally, after a time-out period the user will be automatically logged-out of the web interface. However, if it is expected that more time is required configuring the unit, the login page provides a check box to disable to auto log-out on this system, leaving the user logged in until an explicit log-off is triggered or the web-browser window is closed.

### ***Home Screen***

Once logged in, the web interface will display the home screen. The home screen provides current status information about the CS-700 unit, including System Status, Media (USB, streaming) status, and Bluetooth status.

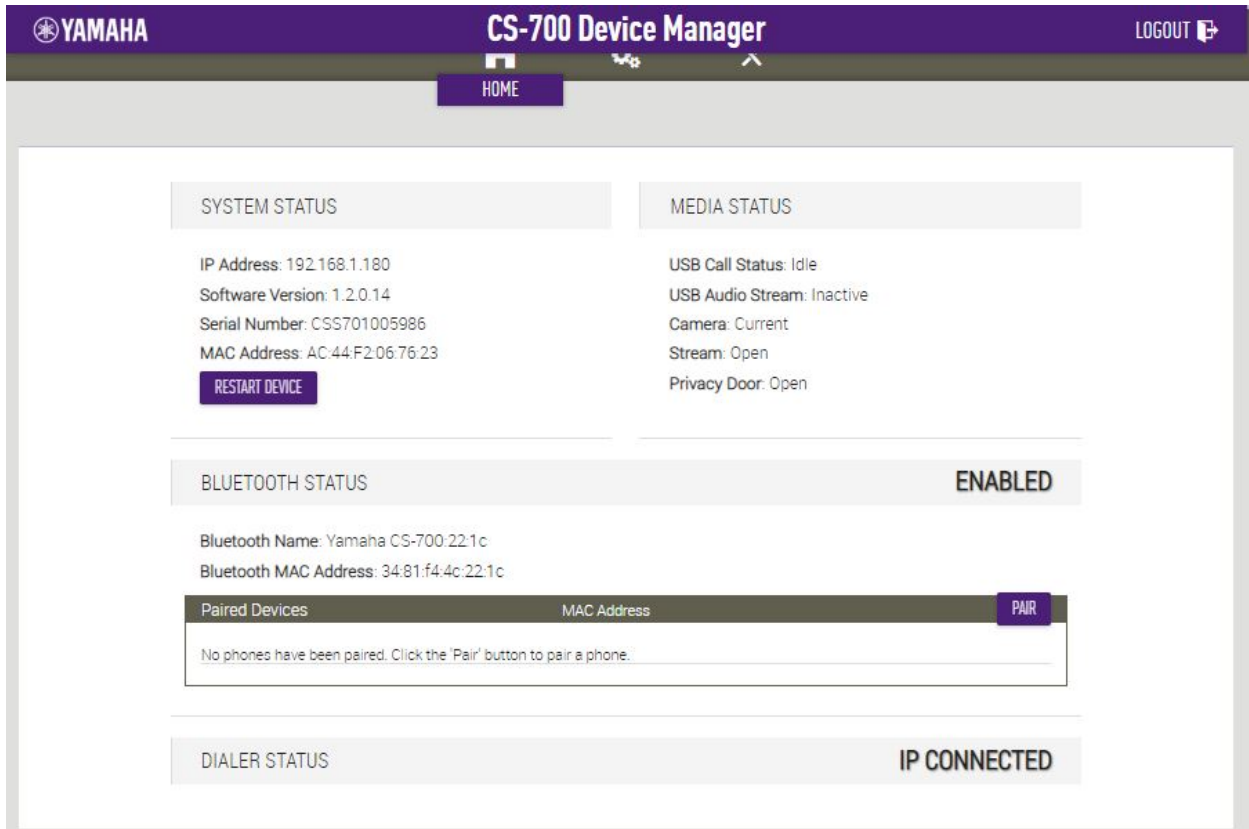

The home screen allows initiating an immediate restart of the device, by clicking on the Restart Device box.

In all screens of the web UI, a logout icon is displayed in the upper right corner allowing the user to log off from the unit.

The top menu line allows accessing the different pages of the web UI. Hovering over any of the symbols will show the available options. The Settings options allow configuring the unit. The Tools menu allows system firmware upgrades and uploading / downloading of log files and configuration files. The Settings and Tools options are described in more detail in the following sections.

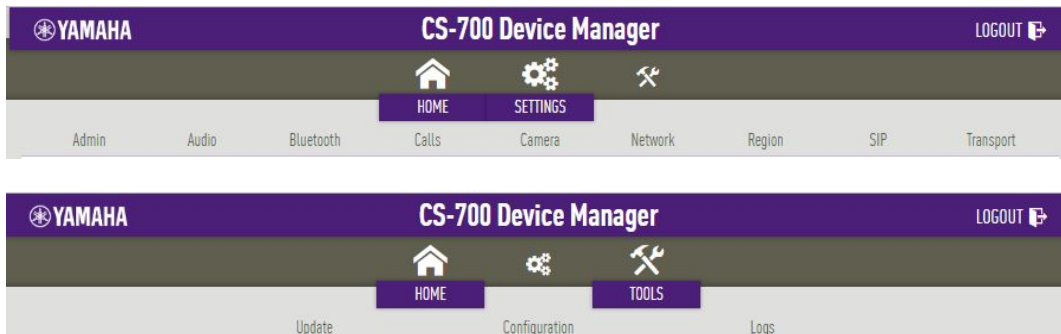

Please note that for any changes to take effect, the “submit” button on the web page has to be clicked. Otherwise changes will get lost when leaving the page without clicking “submit” before.

## Settings

### Admin

The admin tab allows setting of several administrative parameters.

#### Password and System name

In this area the administrator can change the system password. The password has a minimum length of four characters, any alphanumeric and symbols are allowed. Once a valid password has been entered, it needs to be entered a second time to protect against typos and unwanted changes.

System Name allows the administrator to provide a descriptive name to the CS-700. Factory default this name is CS-700 and the MAC address.

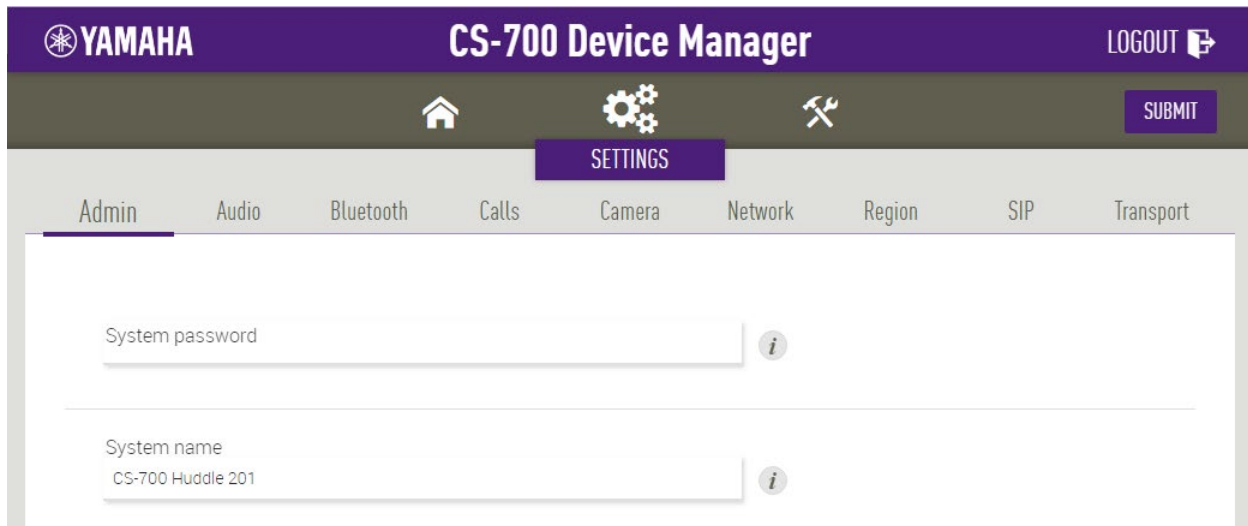

The screenshot displays the Yamaha CS-700 Device Manager interface. At the top, there is a purple header with the Yamaha logo, the title "CS-700 Device Manager", and a "LOGOUT" button. Below the header is a navigation bar with icons for Home, Settings (active), and Tools, and a "SUBMIT" button. The main content area has a tabbed interface with "Admin" selected. Under the "Admin" tab, there are two input fields: "System password" and "System name". The "System name" field contains the text "CS-700 Huddle 201". Each input field has an information icon (i) to its right.

YAMAHA CS-700 Device Manager LOGOUT

SECURITY SETTINGS SUBMIT

Enable call history *i*

Require HTTPS *i*

Enable room control access  
Room control enabled using Telnet *i*

Room control password *i*

The “Enable recent calls” selection enables / disables keeping a list of the last phone calls made from or to the CS-700. When disabled no information on the calls will be kept on the system.

When “Require HTTPS” is enabled, the web interface will switch from http to https. Please note that when using HTTPS, the CS-700 device does not have a certified security certificate and the web browser will warn of a potentially unsecure connection.

“Enable room control access” allows the Telnet or SSH interface into the CS-700 to be opened. Changing this setting will reboot the CS-700 unit. Username and factory default password for the Telnet/SSH access are **roomcontrol** and **Yamaha-CS-700**, respectively.

The Room control password for the **roomcontrol** user can be changed. Enter the password of your choice, and confirm it.



## Dialer Restriction Settings

The screenshot shows the 'DIALER RESTRICTIONS SETTINGS' page in the Yamaha CS-700 Device Manager. The page has a purple header with the Yamaha logo, 'YAMAHA CS-700 Device Manager', and a 'LOGOUT' button. Below the header is a light gray bar with the title 'DIALER RESTRICTIONS SETTINGS' and a 'SUBMIT' button. The main content area contains three settings, each with an unchecked checkbox and an information icon:

- Disable call history modification *i*
- Disable contacts modification *i*
- Disable Do not Disturb (DnD) setting *i*

The dialer restriction settings allow limiting the changes a user can do.

Audio modification defines whether a user can change the ringer volume or not. Recent call modification identifies whether a user can change the recent call list. Contacts modification does the same for the contacts list. And finally the DnD functionality can be enabled or disabled for the user.

## Front Panel Settings

The screenshot shows the 'FRONT PANEL SETTINGS' page in the Yamaha CS-700 Device Manager. The page has a purple header with the Yamaha logo, 'YAMAHA CS-700 Device Manager', and a 'LOGOUT' button. Below the header is a light gray bar with the title 'FRONT PANEL SETTINGS' and a 'SUBMIT' button. The main content area contains five settings, each with a checked checkbox and an information icon:

- Enable camera button *i*
- Enable audio button *i*
- Enable volume buttons *i*
- Enable bluetooth button *i*
- Enable call light *i*

All of the front-panel CS-700 control buttons can be individually enabled or disabled through these check boxes. De-selecting the respective setting will disable the corresponding front panel button and light.

POWER SAVING SETTINGS

Enable power saving mode *i*

Timeout (minutes)

1 *i*

The CS-700 unit will automatically enter into Power Saving Mode whenever idle state is detected, and re-energize when activity is detected. This feature is controlled through the Enable Power Saving Mode checkbox. When the power savings setting is enabled, the user can select the time (in minutes) after which the system will go into power savings mode. This feature is set by factory default with a 20 minute power savings time.

The CS-700 will wake up when activity is detected, either on the Aux in, the USB connection, or a button is pressed. Please allow about 10 seconds for the system to wake up.

When the SIP interface is configured on the CS-700SP due to the requirements of the network and SIP interface, the unit will not go into sleep mode.

## SNMP Settings

The screenshot shows the 'SNMP SETTINGS' page in the 'YAMAHA CS-700 Device Manager'. The page has a purple header with the Yamaha logo, the title 'CS-700 Device Manager', and a 'LOGOUT' button. Below the header is a grey bar with 'SNMP SETTINGS' and a 'SUBMIT' button. The main content area contains several settings:

- Enable SNMP *i*
- Server address *i*
- Read-only community: public *i*
- Device location: unknown *i*
- Contact name: unknown *i*

The CS-700 will report SNMP MIB events (Traps) and provide status updates to SNMP polls when this feature is enabled with the Enable SNMP box. Provide the SNMP server IP address to complete the process. See the Appendix for details on the SNMP MIB and traps supported.

## Deployment Server Settings

The screenshot shows the 'DEPLOYMENT SERVER SETTINGS' page in the 'YAMAHA CS-700 Device Manager'. The page has a purple header with the Yamaha logo, the title 'CS-700 Device Manager', and a 'LOGOUT' button. Below the header is a grey bar with 'DEPLOYMENT SERVER SETTINGS' and a 'SUBMIT' button. The main content area contains several settings:

- Enable deployment server *i*
- Enable automatic server discovery *i*
- Provisioning interval (minutes) *i*: 1440

The Deployment Server Settings allows specifying automatic ways to download configuration data and firmware upgrade to the CS-700 on a reboot.

Factory Default, the system is set to support automatic server discovery for a deployment server using DHCP option 66 and DHCP option 150.

When deployment server is enabled but automatic server discovery is disabled, a primary (and secondary) deployment sever can be statically entered from which the CS-700 will download the configuration data at start-up.

Using DHCP option 66, the return can be an address or a hostname of a TFTP server, FTP server, or HTTP server. Option 150, a list of addresses of TFTP servers, FTP servers, or HTTP servers might be delivered back. When using the static server addresses, addresses of TFTP servers, FTP servers, or HTTP servers might be provided.

When using the deployment server, the CS-700 will look for a file named <<MAC-address of unit>>.xml in the provided location(s). See the remote configuration section for sample configuration and a list of the available configuration parameters.

The provisioning interval allows specifying the time interval when a system should re-check for possible configuration changes. This interval can be set between 1 minute and 31 days (44,640 minutes). Default is set for 24-hours (1440 minutes). At the end of a provisioning interval, if a change to the configuration file is identified, the CS-700 will reboot and restart using the new configuration file, including any firmware updates included in the configuration. The re-configuration and reboot will ONLY occur once any ongoing sessions have terminated and the unit has returned to idle state.

## Audio

The Audio section of the Settings menu supports managing the audio behavior of the CS-700.

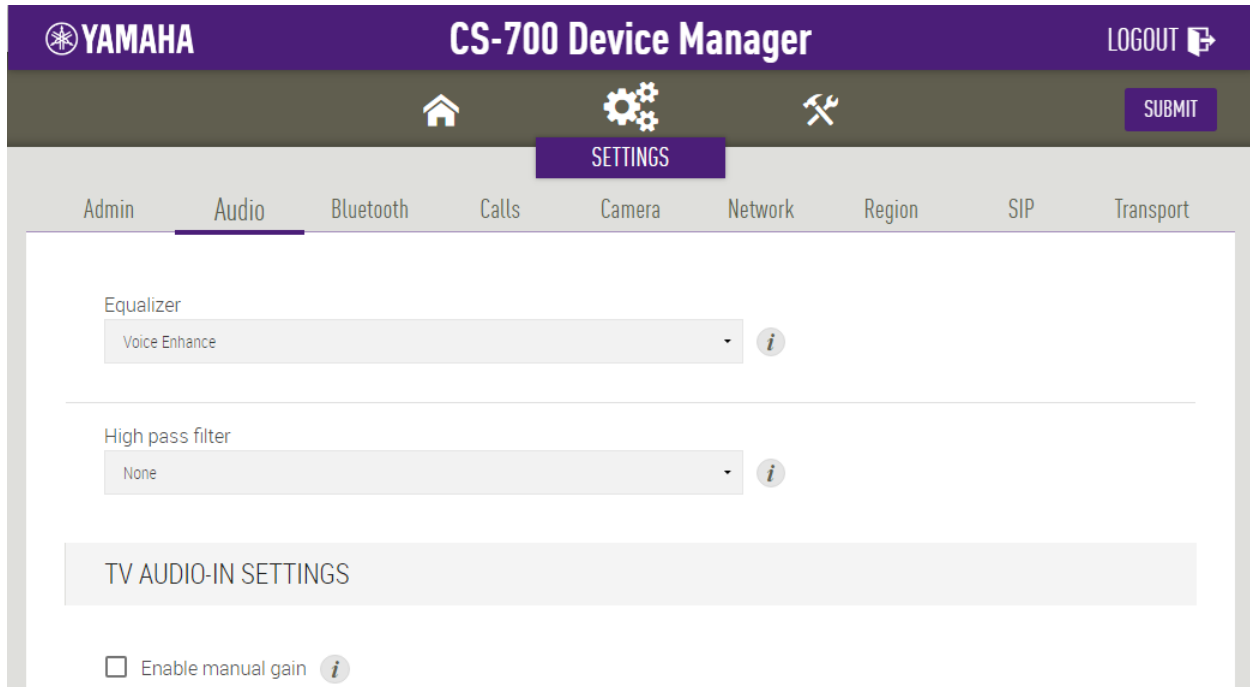

The Equalizer setting allows selecting one of a list of pre-defined speaker equalizations. The available choices are Voice Enhance, Bass Boost, and Treble Boost.

The High Pass filter affects the microphones and can be used to filter out low frequency noises in the room. The high pass filter can be disabled (None), or set to the provided frequencies of 110Hz, 140Hz, 175Hz, or 225Hz.

The TV Audio-In Settings allow gain-control of the AUX-in input sound source. The default setting is automatic gain control. Enabling manual gain allows the Operator to select a pre-defined gain level from -12dB to +40dB.

YAMAHA CS-700 Device Manager LOGOUT

WIRELESS MICROPHONES SETTINGS SUBMIT

Enable wireless omni-directional microphone *i*

Enable wireless directional microphone *i*

Enable wireless lapel microphone *i*

Wireless Microphone Settings allows the administrator to select the types of wireless microphones that are connected to the CS-700 as extension microphones. CS-700 offers three different types of wireless extension microphones that are omni-directional microphone, directional microphone and lapel microphone. Up to two microphones can be used in the same time with any combinations. Selecting type of wireless microphone optimizes the microphones to be better pick-up audio quality.

The “Enable wireless omni-directional microphone” enables additional audio processing of extension wireless omni-directional microphone. System defaults to disabled.

The “Enable wireless directional microphone” enables additional audio processing of extension wireless directional microphone. System defaults to disabled.

The “Enable wireless lapel microphone” enables additional audio processing of extension lapel microphone. System defaults to disabled.

The screenshot shows the 'Media Settings' interface for a Yamaha CS-700 device. At the top, there is a purple navigation bar with the Yamaha logo, the text 'YAMAHA CS-700 Device Manager', and a 'LOGOUT' button with an external link icon. Below this is a light gray header for the 'MEDIA SETTINGS' section, which includes a 'SUBMIT' button on the right. The main content area is titled 'Audio codec' and features an information icon. It is divided into two sections: 'Enabled' and 'Disabled'. The 'Enabled' section contains five draggable items representing different audio codecs: G.722, G.711 μ-law (PCMU), G.711 A-law (PCMA), G.726, and G.729. The 'Disabled' section is currently empty. Below the codec sections is a 'Codec ptme override (ms)' section, also with an information icon. It includes a horizontal slider and a text input field that is currently set to '20'.

Media Settings allows the administrator to select the VoIP codecs that are enabled / disabled in the unit by dragging and dropping them into the according areas. Within the enabled area, the order from top to bottom gives the ranking in which the codecs will be offered. Supported codecs are G.711 u-law and G.711 a-law, G.722, G.726, and G.729.

The Codec ptme override can be set to values between 10 and 100 milliseconds. Factory preset is 20 ms.

## Bluetooth Settings

The screenshot shows the 'Bluetooth Settings' page in the Yamaha CS-700 Device Manager. The page has a dark purple header with the Yamaha logo, 'CS-700 Device Manager', and a 'LOGOUT' button. Below the header is a navigation bar with icons for Home, Settings, and Tools, and a 'SUBMIT' button. The main content area has a tabbed interface with 'Bluetooth' selected. The settings include: 'Enable Bluetooth' (checked), 'Enable NFC' (checked), 'Device name' (CS-700 Huddle 201), 'Pairing pin' (0000), 'Pairing and connection timeout (seconds)' (60), 'Bluetooth call auto-join' (unchecked), and 'Bluetooth device auto-unpair' (unchecked). Each setting has an information icon (i).

The “Enable Bluetooth” box allows system-wide control of all Bluetooth capability. De-selecting this box will shut-down Bluetooth communications to the CS-700 and disable the Bluetooth and NFC front-panel indicator buttons. System defaults to Bluetooth-enabled.

The “Enable NFC” box allows control over the NFC pairing feature. De-selecting this box will disable the NFC pairing feature associated with the NFC front-panel indicator button. System defaults to NFC-enabled.

The Device Name allows modification of the Bluetooth Basic Rate advertised device name – the name seen when connecting to the unit. The default value is Yamaha cs-700 <MAC of this device>.

The Pairing PIN defines the 4-digit Bluetooth Basic Rate PIN for pairing, with default set to “0000”.



The Pairing and Connection Timeout setting allows control over the Bluetooth Basic Rate pairing mode and connection mode timeout in seconds. After this time, pairing mode or the connecting mode will terminate. A value of 0 indicates no timeout. The default value is 60 sec.

The “Bluetooth call auto-join” allows a Bluetooth call on the paired and linked Bluetooth device to automatically join a conference if there is no dialer control app. System defaults to Bluetooth call auto-join – disabled.

The “Bluetooth device auto-unpair” allows CS-700 to automatically unpair a linked Bluetooth device when that device disconnects. This option will prevent Bluetooth auto-connection. When this option is enabled, a pairing operation is required for each Bluetooth connection. System defaults to Bluetooth device auto-unpair - disabled.

### Calls

The screenshot shows the 'Settings' page for the 'CS-700 Device Manager'. The 'Calls' tab is selected, and the following settings are visible:

- Enable message waiting indication *i*
- Set Do not Disturb (DnD) mode *i*
- Enable auto-answer *i*
- Ring tone: Ring 1 *i*
- Voicemail number:
- Maximum call duration: 0 *i*
- Dial plan:

The calls section allows defining behavior and options available to the user around call behavior.

Enable Message Waiting indicator allows the dialer to show information on possible voice messages that are stored on the server for this number.

Set DnD puts the phone into this mode by default.

Enable auto-answer automatically answers any incoming call. This setting is not recommended to be used.

The Ring tone selection offers several ring tones as stored on the device.

Provide a voicemail number to allow picking up voice mails with one button press from the dialer.

Maximum call duration allows setting a maximum number for a phone call in minutes. The default of “0” means no maximum.

If a dial plan is required for the phone please enter the dial plan string here. See the Appendix for a definition of the dial plan string.

### *Forwarding Settings*

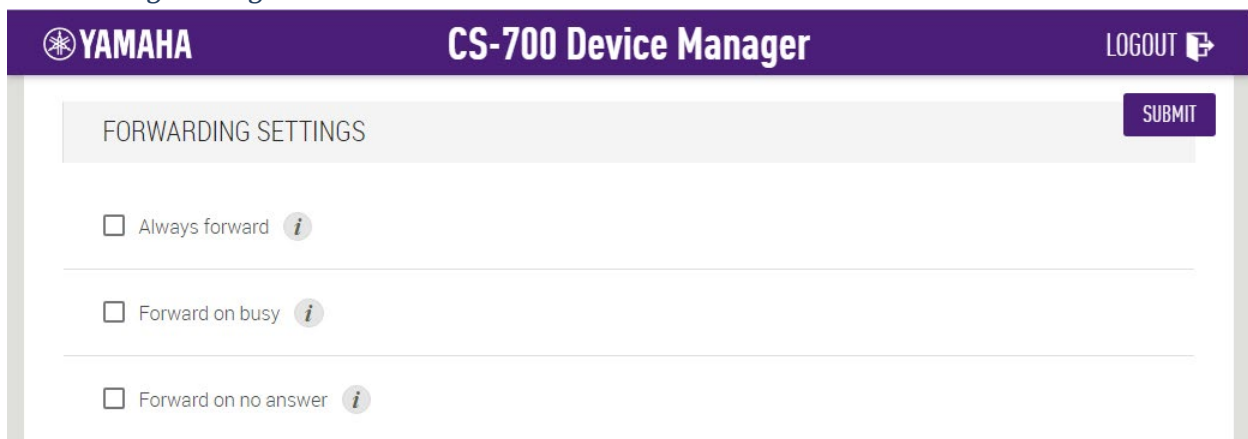

The screenshot shows the 'Forwarding Settings' page in the Yamaha CS-700 Device Manager. The page has a purple header with the Yamaha logo, 'YAMAHA CS-700 Device Manager', and a 'LOGOUT' button. Below the header is a light gray bar with the title 'FORWARDING SETTINGS' and a 'SUBMIT' button. The main content area contains three settings, each with an unchecked checkbox and an information icon (i):

- Always forward *i*
- Forward on busy *i*
- Forward on no answer *i*

The Forwarding settings allow specifying under which conditions calls should be forwarded, and to which number.

### *Camera*

The Camera settings area allows reviewing the current settings of the camera, and allows applying them as home settings or default settings.

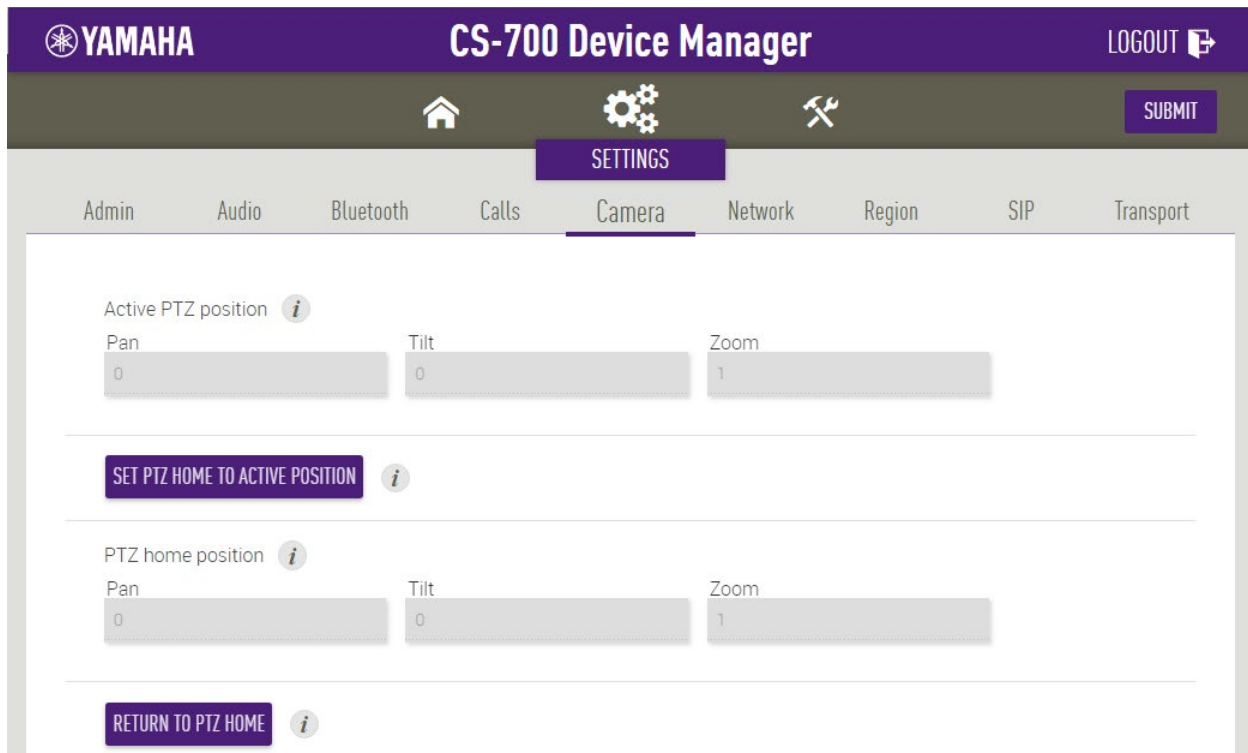

The current “active” Pan, Tilt, and Zoom (PTZ) settings of the camera will be shown in this page. They cannot be changed from the Web UI. The PTZ settings can be changed using the Service Application described later in this document, or using UC applications that offer camera control.

Note that in the CS-700 Pan and Tilt settings are only effective when Zoom has been set to a value greater than 100.

The ZOOM setting allows the Operator to electronically adjust the camera zoom up to 4x from default.

Pan and Tilt default to 0, Zoom defaults to 100.

Clicking the “Set PTZ Home to Active Position” button preserves the current Pan/Tilt/Zoom settings as the camera home position. The CS-700 will return to this position whenever a USB connection is re-established.

“Return to PTZ Home” will reset the active PTZ settings to the PTZ home settings.

**YAMAHA**
**CS-700 Device Manager** LOGOUT

---

Active image settings

Backlight <input style="width: 90%;" type="text" value="3"/>	Brightness <input style="width: 90%;" type="text" value="125"/>	Contrast <input style="width: 90%;" type="text" value="110"/>
Saturation <input style="width: 90%;" type="text" value="100"/>	Sharpness <input style="width: 90%;" type="text" value="85"/>	Hue <input style="width: 90%;" type="text" value="90"/>
		Gamma <input style="width: 90%;" type="text" value="255"/>

SUBMIT

---

SET IMAGE SETTINGS TO ACTIVE

---

Camera Image settings

Backlight <input style="width: 90%;" type="text" value="3"/>	Brightness <input style="width: 90%;" type="text" value="125"/>	Contrast <input style="width: 90%;" type="text" value="110"/>
Saturation <input style="width: 90%;" type="text" value="100"/>	Sharpness <input style="width: 90%;" type="text" value="85"/>	Hue <input style="width: 90%;" type="text" value="90"/>
		Gamma <input style="width: 90%;" type="text" value="255"/>

---

RETURN TO DEFAULT IMAGE SETTINGS

---

Power Line Frequency for Anti-Flicker

Active Image settings act in the same way as the PTZ values. The current settings show the currently active settings for the camera. The camera image settings are the default settings applied whenever a new USB connection is being made. Pressing the “Set Image Settings to Active” button will copy the current active settings to the image settings.

Return to default image settings returns the settings to the factory default.

Finally, the Power Line Frequency for Anti-Flicker setting allows selecting the frequency of the power line. In environments using florescent lighting the image of the CS-700 might be flickering unless the images sent are adjusted to the power frequency.

## Network

The screenshot displays the Network configuration page in the CS-700 Device Manager. At the top, there is a purple header with the Yamaha logo and 'CS-700 Device Manager', and a 'LOGOUT' button. Below the header is a navigation bar with icons for Home, Settings, and Tools, and a 'SUBMIT' button. The 'SETTINGS' menu is open, and 'Network' is the selected tab. The Network settings are as follows:

- Enable DHCP *i*
- IP address: 10.10.10.10 *i*
- Subnet mask: 255.255.252.0 *i*
- Default gateway: 10.10.10.1 *i*
- Primary DNS: 10.10.10.2 *i*
- Secondary DNS: *i*
- Voice VLAN: Automatic *i*

The Network section allows specifying the IP configuration for the CS-700. Factory default, the device is set to DHCP enabled and no further IP settings are required. However, if a static IP address is to be assigned, “Enable DHCP” needs to be unchecked, and the static IP parameters can be provided.

Voice VLAN allows specifying if a VLAN is used. Automatic will detect a VLAN ID and connect on that VLAN. Enabled will require a VLAN ID to be provided manually. And Disabled will disable connections to VLAN networks.

## Authentication Settings

The screenshot shows the 'Authentication Settings' page in the Yamaha CS-700 Device Manager. The page has a purple header with the Yamaha logo, 'YAMAHA', 'CS-700 Device Manager', and a 'LOGOUT' button. Below the header is a light gray bar with 'AUTHENTICATION SETTINGS' and a 'SUBMIT' button. The main content area includes a checked checkbox for 'Enable 802.1x authentication' with an information icon. Below this is a dropdown menu for 'Authentication method' set to 'MD5'. There are two text input fields: 'Username' and 'Password', both with 'This field is required.' error messages below them.

Authentication Settings provides the option to enable 802.1x authentication on the CS-700. To enable 802.1x authentication, check the Enable 802.1x authentication setting. Supported authentication type is MD5.

A username and password are needed to complete the authentication process.

## Region

The screenshot shows the 'Region' settings page in the Yamaha CS-700 Device Manager. The page has a purple header with the Yamaha logo, 'CS-700 Device Manager', and a 'LOGOUT' button. Below the header is a navigation bar with icons for Home, Settings, and Tools, and a 'SUBMIT' button. The 'SETTINGS' menu is active, and the 'Region' sub-menu is selected. The main content area contains two settings: 'System language' set to 'English' and 'Regional call progress tones' set to 'USA'. Both settings have an information icon (i) to their right.

In the Regions menu, the System language allows selecting the language.

The Regional call progress tones allow adapting the tones heard while setting up calls to the local typical tones.

## Time Settings

The screenshot shows the 'Time Settings' page in the Yamaha CS-700 Device Manager. The page has a purple header with the Yamaha logo, 'CS-700 Device Manager', and a 'LOGOUT' button. Below the header is a navigation bar with icons for Home, Settings, and Tools, and a 'SUBMIT' button. The 'SETTINGS' menu is active, and the 'Time Settings' sub-menu is selected. The main content area contains a 'TIME SETTINGS' section with a 'SUBMIT' button. The 'NTP support' checkbox is checked. Below it are four text input fields for 'Network time server 1' through '4', each with an information icon (i) to its right. The values in the fields are '0.pool.ntp.org', '1.pool.ntp.org', '2.pool.ntp.org', and an empty field for the fourth server.

When selecting “NTP support”, up to 4 network time servers can be listed to provide NTP time information. These can be local servers or network servers.

The screenshot shows the Yamaha CS-700 Device Manager interface. At the top, there is a purple header with the Yamaha logo, the title "CS-700 Device Manager", and a "LOGOUT" button. Below the header is a navigation bar with icons for Home, Settings (selected), and Tools, along with a "SUBMIT" button. The main menu includes "Admin", "Audio", "Bluetooth", "Calls", "Camera", "Network", "Region", "SIP" (selected), and "Transport". The "SIP" section is titled "REGISTRATION SETTINGS" and contains four input fields: "Registrar" (with the value "10.10.10.5"), "Backup registrar", "VoIP realm" (with the value "\*"), and "Proxy". Each input field has an information icon (i) to its right.

In this menu the SIP configuration settings are located configuring the CS-700 with the call manager. Registrar and Back-up registrar (if configured) are the IP addresses or domain names of the Call Manager. If configured, a Proxy address can be provided, and an indicator whether the proxy should also be used for registration. The VoIP realm, typically "\*", can also be provided.



Username

1234



SUBMIT

Password

.....



User ID

1234



Display name

1234



Registration timeout

60



Registration retry interval

300



The next section contains the user name, User ID and password for the logon to the Call Manager. Please note that Call Managers often use different names for these parameters and a correct mapping is required for the logon to the call manager to be successful.

**YAMAHA** **CS-700 Device Manager** **LOGOUT**

**CONFIGURATION SETTINGS** **SUBMIT**

Use SIP session timers  
Optional ⓘ

Session timers expiration  
1800 ⓘ

Session timers min expiration  
90 ⓘ

Require reliable SIP provisional response ⓘ

Enable SIP traversal behind symmetric NAT ⓘ

Suppress SIP event subscription during call transfer ⓘ

Allow strict routing ⓘ

The Configuration Settings section offers several advanced SIP settings. These parameters should be aligned with the call manager configuration.

**YAMAHA** **CS-700 Device Manager** **LOGOUT**

Minimize SIP message size ⓘ **SUBMIT**

DTMF signaling method  
RTP (RFC2833) ⓘ

DTMF RTP payload type ⓘ  
96

Media on-hold method  
M line only (RFC3264) ⓘ

Select “Minimize SIP message size” if SIP messages are getting too long in the network. This setting allows headers of messages in abbreviated format. Ensure that your Call Manager supports minimized SIP message.

The CS-700 supports several means to transport DTMF information entered during a call to the far end. This setting should be consistent with the method supported by the call manager.

The SIP standard defines the payload range for DTMF tones. Some call managers do not accept all payload types, select the supported payload type in this setting.

Lastly, some call managers require RFC 2543 for on-hold media. For these call managers, change the Media on-hold message to that value.

## Transport

The screenshot shows the 'Transport' settings page in the Yamaha CS-700 Device Manager. The page has a purple header with the Yamaha logo, 'CS-700 Device Manager', and a 'LOGOUT' button. Below the header is a navigation bar with icons for Home, Settings (active), and Tools, and a 'SUBMIT' button. The main content area has a menu with 'Admin', 'Audio', 'Bluetooth', 'Calls', 'Camera', 'Network', 'Region', 'SIP', and 'Transport' (selected). The settings are as follows:

- Enable QoS *i*
- Enable TCP transport protocol *i*
- Local port: 5060 *i*
- Enable SRTP: Disabled *i*
- RTP port: 4000 *i*
- SIP/RTP IP address: *i*
- STUN server: *i*

The Transport section of the management interface allows configuring specific transport methods based on call manager settings and network and firewall configurations.

If QoS is enabled, SIP and media packages are tagged to indicate QoS requirements.

Typically SIP messages are sent using UDP (if available). By checking Enable TCP transport protocol these messages are sent using TCP instead.

The remaining parameters on this page allow specifying the ports used for communication from the device, enable secure RTP, and ICE, TURN, and STUN settings. These parameters should reflect the call manager and network environment in which the CS-700 is used.

## ICE SETTINGS

SUBMIT

Enable ICE 

SUBMIT

Enable aggressive ICE nomination 

Disable RTCP 

Max allowed ICE host candidates



## TURN SETTINGS

Enable TURN relay 

TURN server  

This field is required.

Use TCP connection to TURN server 

TURN username  

This field is required.

TURN password  

This field is required.

## Tools

The Tools section of the management interface allows importing and exporting data, resetting the configuration, upgrading the firmware version, and downloading log files.

### Update

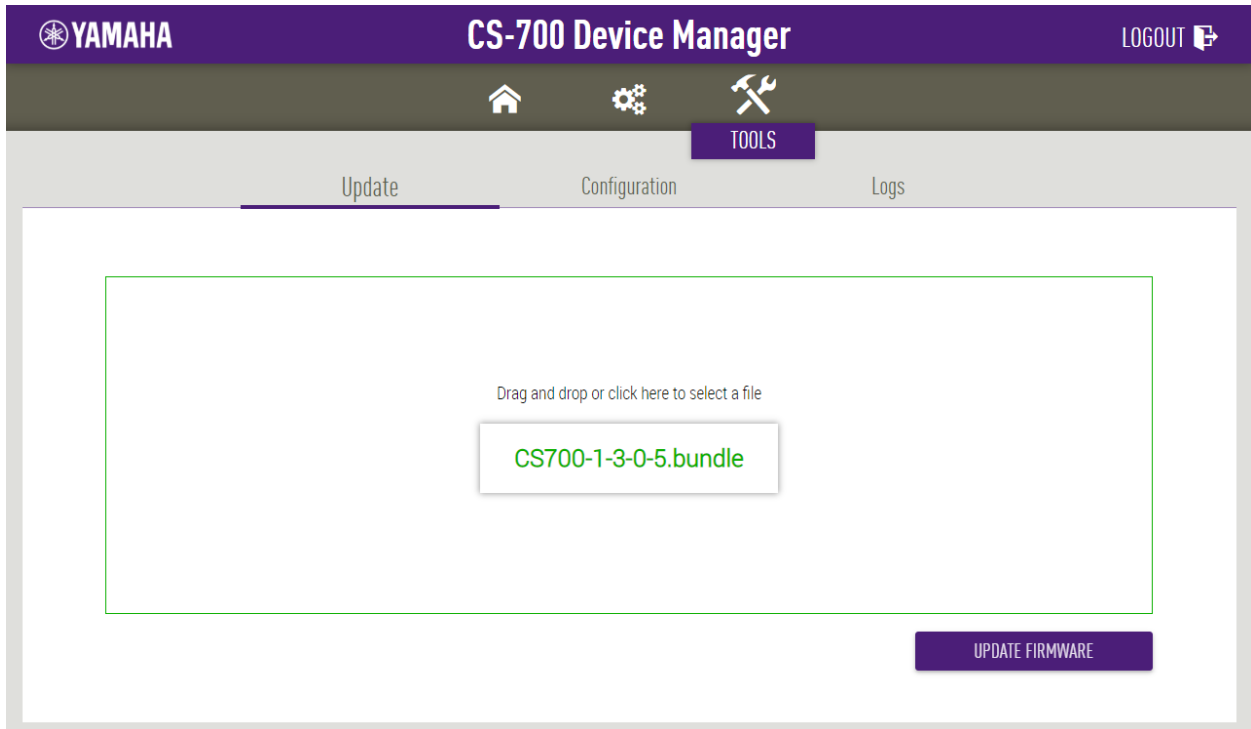

Update allows upgrading the device firmware of the CS-700 using an image bundle on your local PC. Only valid firmware files can be used for an upgrade. Latest firmware can be found on <https://uc.yamaha.com/products/video-sound-bar/huddle-room-system>.

The website allows “drag and drop” of a file, or when clicking in the box a file browser will open to select the firmware file.

Once the firmware file has been identified, clicking the “Update Firmware” button will initiate the upgrade. During the upgrade process, the device will restart automatically. Once the boot-up chime sounds, the upgrade is completed. Give the unit several minutes to update all components and wait for the boot-up chime sound.

## Configuration

The screenshot shows the 'Configuration' page in the CS-700 Device Manager. The page is divided into several sections. At the top, there is a purple header with the Yamaha logo and the text 'CS-700 Device Manager'. To the right of the header is a 'LOGOUT' button. Below the header is a navigation bar with icons for Home, Settings, Tools, and Logs. The 'Tools' menu is expanded, showing 'Update', 'Contacts', 'Configuration' (selected), and 'Logs'. The main content area is titled 'EXPORT CONFIGURATION' and contains a text box explaining that it exports all settings except system and SIP passwords, with an 'EXPORT CONFIGURATION' button. Below this is the 'IMPORT CONFIGURATION' section, which features a large rectangular area for file selection with the text 'Drag and drop or click here to select a file' and an 'IMPORT CONFIGURATION' button.

The configuration page allows Exporting and re-Importing the current configuration of the CS-700. This is specifically of interest if several CS-700 devices are to share identical configurations. The first CS-700 can be fully configured and exported as a “Golden Reference” configuration for the rest of the CS-700 estate. Subsequent CS-700 units can “duplicate” the Golden Configuration by re-Importing the original configuration file. For a description of the configuration parameters, see the provisioning section further down in this manual.

## Reset Defaults

The screenshot shows the 'Reset Defaults' page in the Yamaha CS-700 Device Manager. The page has a purple header with the Yamaha logo, 'CS-700 Device Manager', and a 'LOGOUT' button. Below the header is a light gray box titled 'RESET DEFAULTS'. Inside this box, there are two columns of settings, each with a checkbox: 'SIP settings', 'Call history', 'Network settings', 'Bluetooth settings', 'Wireless Dialer' in the first column; and 'Contacts', 'Audio settings', 'Camera settings', 'Restore ALL defaults' in the second column. To the right of these settings is a purple button labeled 'RESET DEFAULTS'.

System defaults can be restored in a granular way by selecting which settings of the configuration to reset to defaults and then clicking the “Reset Defaults” button. Restore to Factory Defaults restores all settings back to the original settings.

## Logs

The screenshot shows the 'Logs' page in the Yamaha CS-700 Device Manager. The page has a purple header with the Yamaha logo, 'CS-700 Device Manager', and a 'LOGOUT' button. Below the header is a dark gray navigation bar with icons for Home, Configuration, and Tools. The 'Tools' icon is highlighted, and a 'TOOLS' label is visible. Below the navigation bar is a light gray box titled 'Log'. Inside this box, there are three tabs: 'Update', 'Configuration', and 'Logs'. The 'Logs' tab is selected. Below the tabs is a light gray box titled 'DOWNLOAD LOGS'. Inside this box, there is a line of text: 'Download support logs if requested by Yamaha UC technical support. Enable verbose logging below if needed.' Below this text is a checkbox labeled 'Enable verbose logging'. To the right of the checkbox are two purple buttons: 'DOWNLOAD LOGS' and 'SUBMIT'.

The Logs section allows downloading logging information from the CS-700 for analysis. By Factory Default, verbose logging is not enabled and not required. Access to logging information is typically only required when environmental issues with connected devices are experienced. Log files might be requested when contacting Yamaha Customer Support.



## **Service Application**

The CS-700 device can also be configured and managed through a PC connected via USB using a software client called the “Service Application”. The Service Application enables the locally attached Computer to gain access to the CS-700 configuration and operating parameters over the USB cable. Under these conditions, the Network IP link is not required and can be disconnected

The Service Application is designed for use by CS-700 Installation Teams and System Administrators who choose to directly maintain systems, rather than accessing remotely over IP. It can also be used for maintenance tasks while directly being connected to the CS-700 system. The service application also allows adjusting the camera’s Pan, Tilt, and Zoom settings and can be used to adjust the home setting of the camera.

The scope of capabilities in the Service Application is detailed in the following sections.

## Installation & Configuration

For Windows and Mac installations, download the service application installer from <https://uc.yamaha.com/products/video-sound-bar/huddle-room-system/>.

Running the installer application, it first asks you to accept the license agreement. Please read the agreement and if you accept the terms, indicate this below and continue with the installation. If you do not agree with the terms of the license agreement, please cancel the installation process and delete all copies of the installer application.



Next the installer requires the path where the application shall be installed. Please accept the path, or provide the location where the application shall be installed.

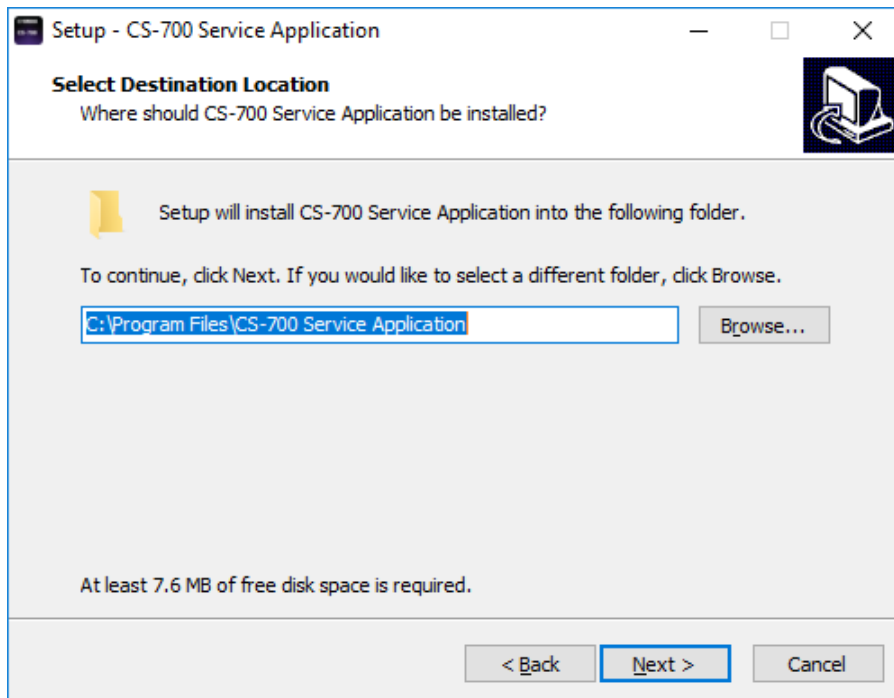

On the next screen select if a desktop shortcut is required:

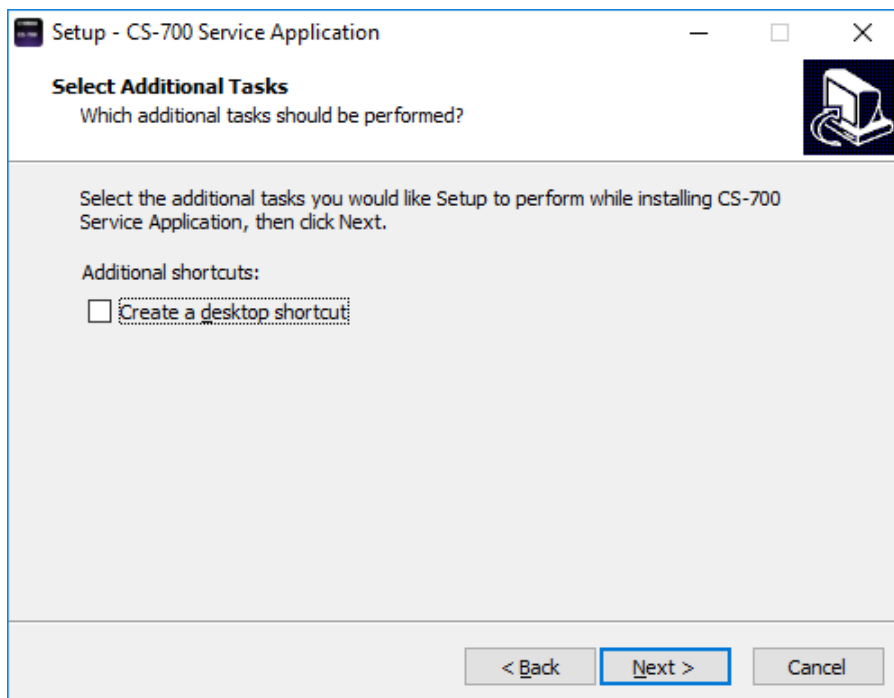

Finally, please confirm the selections and start the installation process.

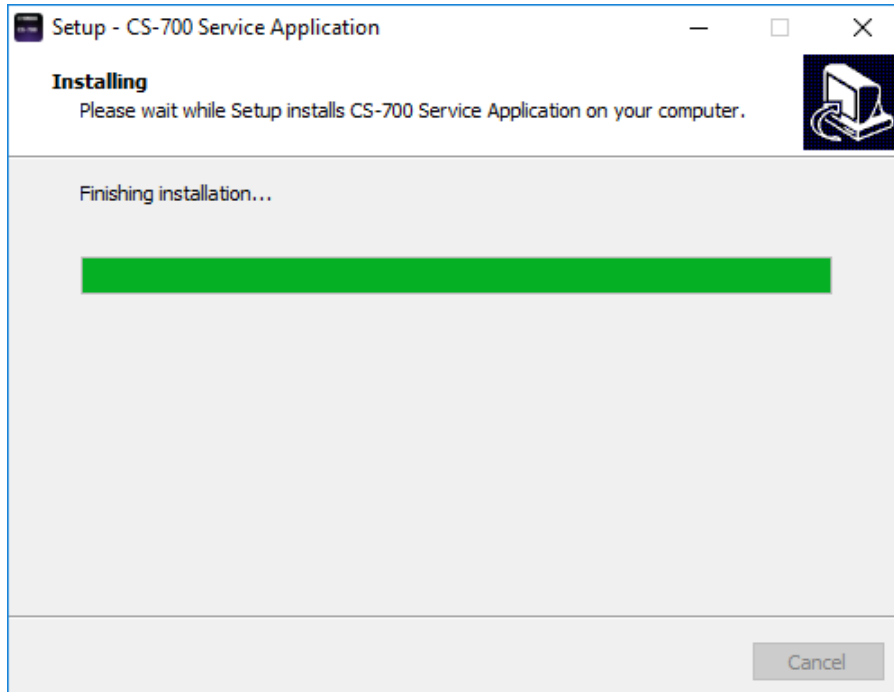
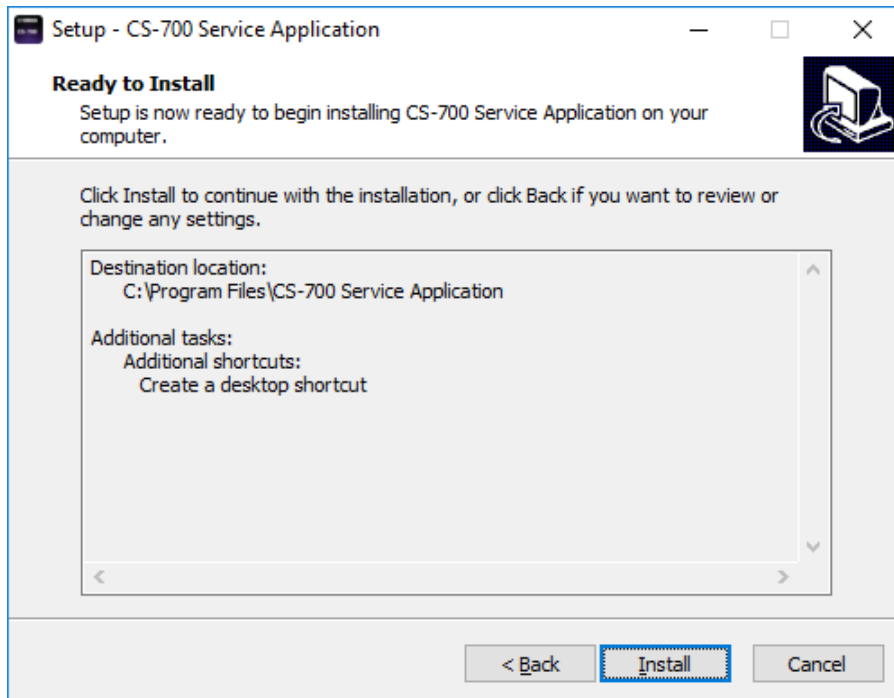

The service application requires an additional device driver for the USB interface which requires confirmation:

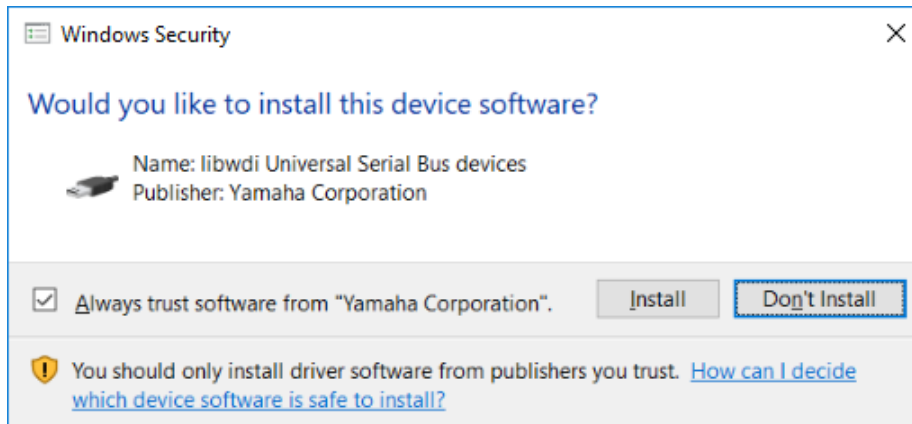

Finally, a window with help information is provided.

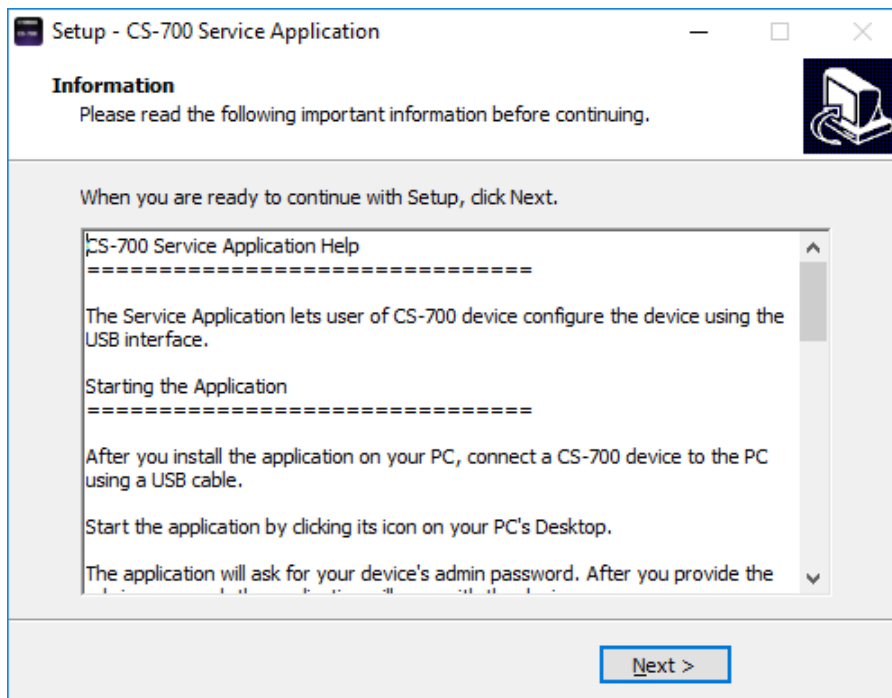

And lastly, the installation process provides a success message after a successful installation.

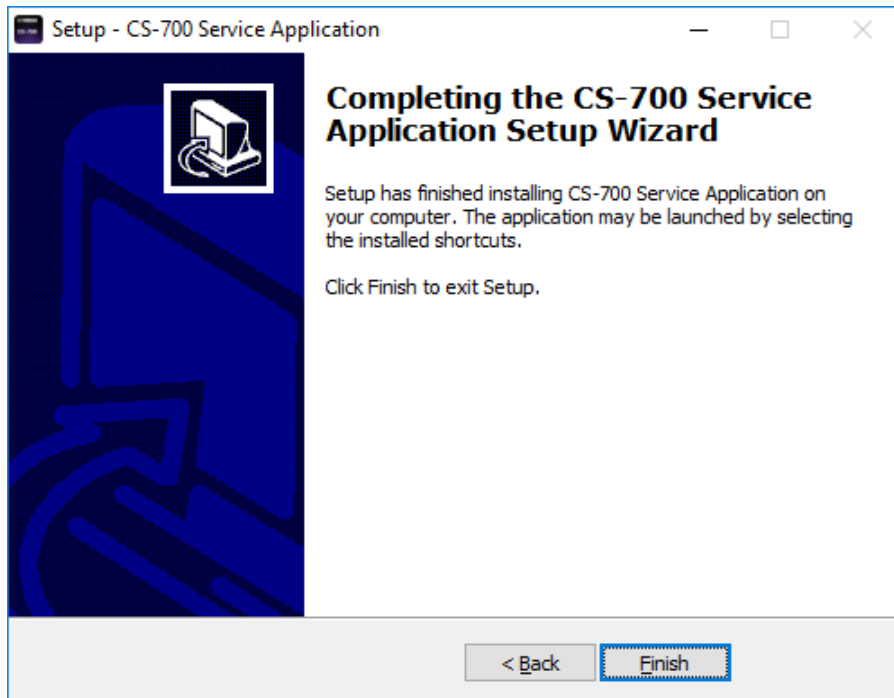

## Using the Service Application

The service application supports similar functionality to the web user interface. However, in some areas it supports less, e.g. in network management, while in others it supports more, e.g. in video control. See the following sections for the supported functionality in the service application.

### Start-up

When starting the service application, a start-up window will be displayed. On the bottom of the application window the current status of the USB connection is displayed.

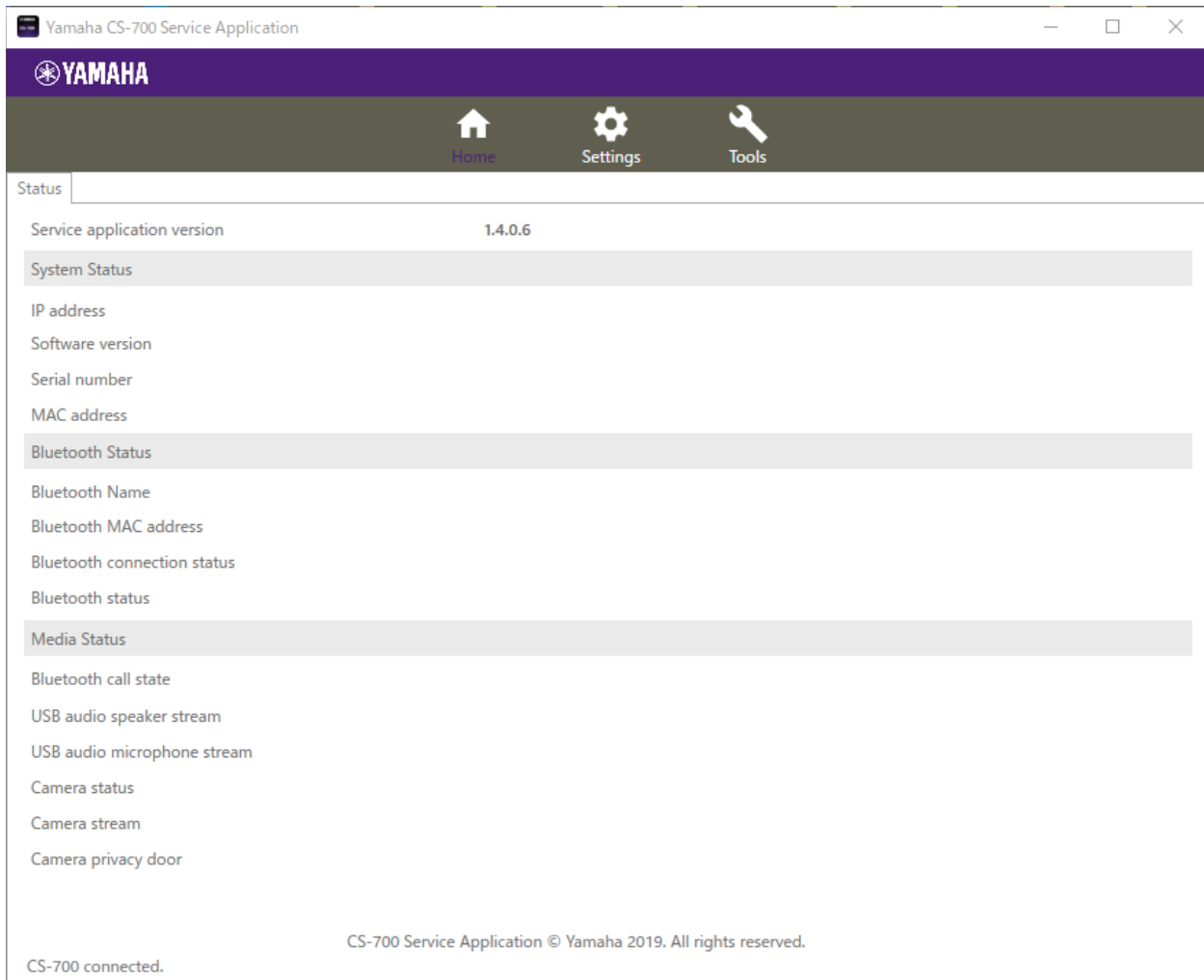

If a CS-700 device is connected and detected no an USB connection, the service application will request the password to access the system. The password is the same as used for any user interface and factory preset to 7386.

CS-700 Service Application

 **YAMAHA**

Please enter the CS-700 admin password:

Login



Once the application logged into the CS-700 device, the home tab will show status information of the unit.

The screenshot displays the Yamaha CS-700 Service Application web interface. At the top, there is a purple header with the Yamaha logo and a navigation bar with three icons: Home (house), Settings (gear), and Tools (wrench). Below the navigation bar, the 'Status' tab is selected. The main content area shows a list of system parameters and their values, organized into sections: System Status, Bluetooth Status, and Media Status. At the bottom, there is a copyright notice and a 'Ready' status indicator.

System Status	
Service application version	1.4.0.6
IP address	10.130.64.120
Software version	1.4.0.2
Serial number	CSS701000186
MAC address	AC:44:F2:06:12:81

Bluetooth Status	
Bluetooth Name	Huddle 201 - CS-700
Bluetooth MAC address	34:81:f4:32:2d:ae
Bluetooth connection status	disconnected
Bluetooth status	Enabled

Media Status	
Bluetooth call state	idle
USB audio speaker stream	closed
USB audio microphone stream	closed
Camera status	Current
Camera stream	closed
Camera privacy door	open

CS-700 Service Application © Yamaha 2019. All rights reserved.

Ready

As in the web UI, changes to parameters require selecting “Submit” for these changes to be sent to the CS-700. If not pressing “Select” and leaving the page, changes will be lost.

## Admin

The Admin area under the Settings menu allows setting system parameters.

The screenshot shows the 'Yamaha CS-700 Service Application' interface. At the top, there is a purple header with the Yamaha logo and a navigation bar with 'Home', 'Settings', and 'Tools' icons. Below this is a sub-menu with 'Admin', 'Audio', 'Bluetooth', 'Camera', and 'Network' tabs. The 'Admin' tab is active, showing three sections: 'Security Settings', 'Front Panel Settings', and 'General Settings'.  
- **Security Settings:** Includes fields for 'System password', 'Re-enter System password', and 'System name' (currently 'CS-700 Huddle 201').  
- **Front Panel Settings:** A list of five checkboxes, all of which are checked: 'Enable camera button', 'Enable audio button', 'Enable volume button', 'Enable Bluetooth button', and 'Enable call light'.  
- **General Settings:** Includes a checked checkbox for 'Enable power saving mode' and a text input field for 'Power saving timeout (minutes)' set to '20'.  
A purple 'Submit' button is located at the bottom right of the form area. At the bottom of the page, it says 'Ready' on the left and 'CS-700 Service Application © Yamaha 2019. All rights reserved.' on the right.

To change the password, provide a new one of at least 4 characters lengths. Any alphanumeric and symbols are allowed. Once a valid password has been entered, it needs to be entered a second time to protect against typos and unwanted changes.

System Name allows the operator to change the reported name of the CS-700 unit, instead of using the MAC address.

All of the front-panel CS-700 control buttons can be individually enabled or disabled through these check boxes. De-selecting the respective setting will disable the corresponding front panel button and light.

The CS-700 unit will automatically enter into Power Saving Mode whenever idle state is detected, and re-energize when activity is detected. This feature is controlled through the Enable Power Saving Mode checkbox. When the power savings setting is enabled, the user can select the time (in minutes) after which the system will go into power savings mode. This feature is set by factory default with a 20 minute power savings time.

The CS-700 will wake up when activity is detected, either on the Aux in, the USB connection, or a button is pressed. Please allow about 10 seconds for the system to wake up.

When the SIP interface is configured on the CS-700SP or CS-700DS version, due to the requirements of the network and SIP interface, the unit will not go into sleep mode.

## Audio

The Audio settings area under the Settings menu allows changing settings in the digital signal processor (DSP) and allows impacting the gain on the auxiliary input (TZ audio).

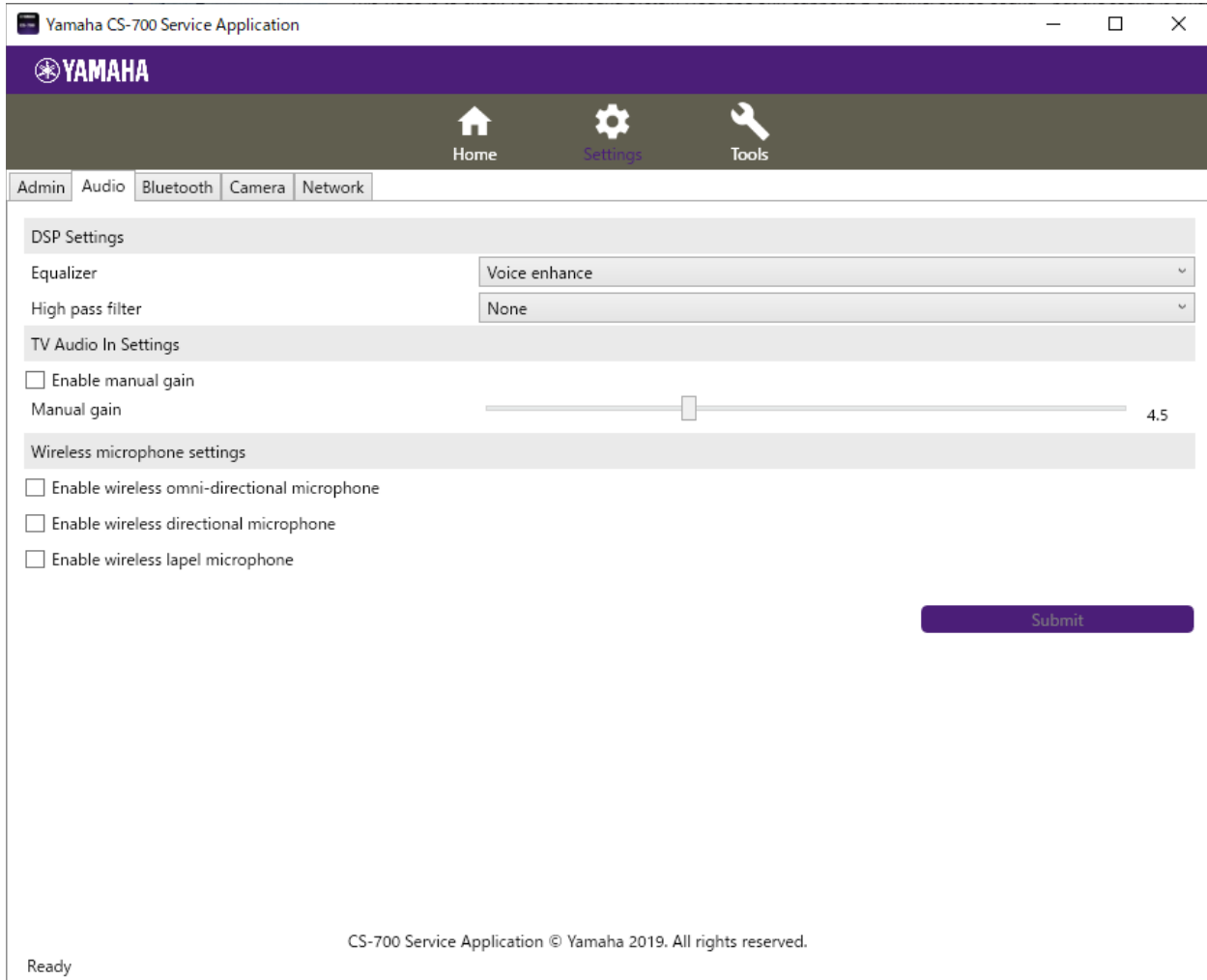

The Equalizer setting allows selecting one of a list of pre-defined speaker equalizations. The available choices are Voice Enhance, Bass Boost, and Treble Boost.

The High Pass filter affects the microphones and can be used to filter out low frequency noises in the room. The high pass filter can be disabled (None), or set to the provided frequencies of 110Hz, 140Hz, 175Hz, or 225Hz.

The TV Audio-In Settings allow gain-control of the AUX-in input sound source. The default setting is automatic gain control. Enabling manual gain allows the Operator to select a pre-defined gain level from -12dB to +40dB.

Note: The signal received on the Aux-in port is not mixed into any output stream. It is only played back in the room using the speakers supporting a sound bar application of the CS-700.

Wireless Microphone Settings allows the administrator to select the types of wireless microphones that are connected to the CS-700 as extension microphones. CS-700 offers three different types of wireless extension microphones that are omni-directional microphone, directional microphone and lapel microphone. Up to two microphones can be used in the same time with any combinations. Selecting type of wireless microphone optimizes the microphones to be better pick-up audio quality.

The “Enable wireless omni-directional microphone” enables additional audio processing of extension wireless omni-directional microphone. System defaults to disabled.

The “Enable wireless directional microphone” enables additional audio processing of extension wireless directional microphone. System defaults to disabled.

The “Enable wireless lapel microphone” enables additional audio processing of extension lapel microphone. System defaults to disabled.

## Bluetooth

In the Bluetooth menu settings affecting the Bluetooth connectivity can be adjusted.

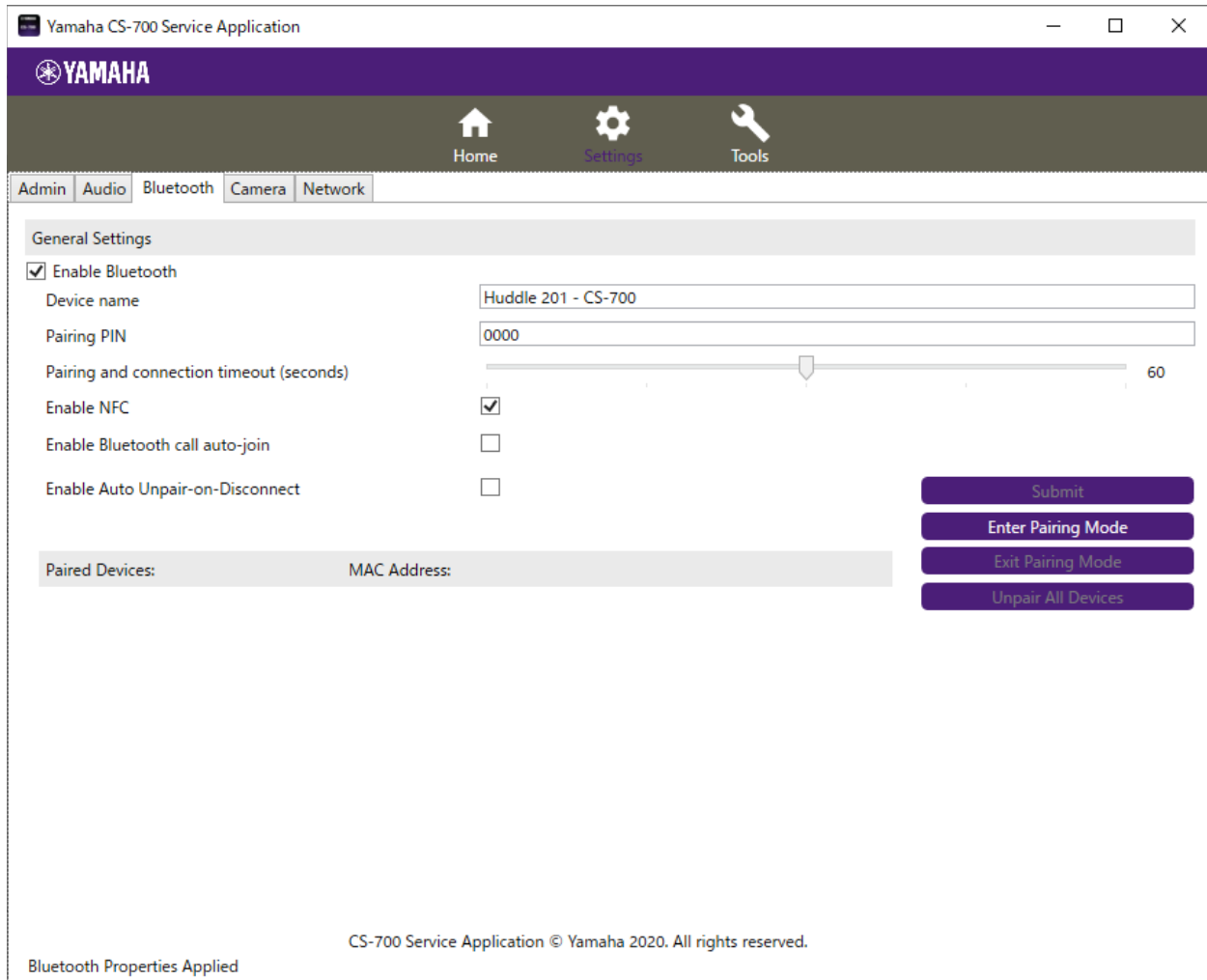

The “Enable Bluetooth” box allows system-wide control of all Bluetooth capability. De-selecting this box will shut-down Bluetooth communications to the CS-700 and disable the Bluetooth and NFC front-panel indicator buttons. The system default is Bluetooth-enabled.

The Device Name allows modification of the Bluetooth advertised device name. The default value is Yamaha CS-700:<last 4 characters of MAC of this device>.

The Pairing PIN defines the 4-digit Bluetooth Basic Rate PIN for pairing, with default set to “0000”.

The Pairing and Connection Timeout setting allows control over the Bluetooth Basic Rate pairing mode and connection mode timeout in seconds. After this

time, pairing mode or the connecting mode will terminate. A value of 0 indicates no timeout. The default value is 60 sec.

The “Enable NFC” box allows control over the NFC pairing feature. De-selecting this box will disable the NFC pairing feature associated with the NFC front-panel indicator button. System defaults to NFC-enabled.

The “Bluetooth call auto-join” allows a Bluetooth call on the paired and linked Bluetooth device to automatically join a conference if there is no dialer control app. System defaults to Bluetooth call auto-join – disabled.

The “Auto Unpair-on-Disconnect” allows CS-700 to automatically unpair a linked Bluetooth device when that device disconnects. This option will prevent Bluetooth auto-connection. When this option is enabled, a pairing operation is required for each Bluetooth connection. System defaults to Bluetooth Auto Unpair-on-Disconnect - disabled.

When clicking Enter Pairing Mode the Yamaha CS-700 starts to broadcast its Bluetooth information and can now be found from other Bluetooth devices. Exit Pairing Mode will end the broadcast of the Bluetooth information. Unpair All Devices will remove all Bluetooth information of previously paired devices.

## Camera

The Camera tab allows invoking the electronic Pan/Tilt/Zoom settings of the CS-700. Pan and Tilt will only work when the camera has zoomed in. Zoom values are from 100 – 400, Tilt from -18 to +18, Pan from -30 to +30. At the maximum zoom of 400, the camera offers a 36degree field of view.

Once satisfied with the settings, they can be saved as Camera Settings with clicking “Save Current Camera Settings”. The Camera Settings are automatically applied every time a new USB connection is being made to the CS-700. Clicking on “Restore Previous Camera Settings” will restore the camera to the stored Camera Settings.

Finally, the Power line frequency for anti-flicker setting allows selecting the frequency of the power line. In environments using fluorescent lighting the image of the CS-700 might flicker unless the camera setting matches the actual power frequency.

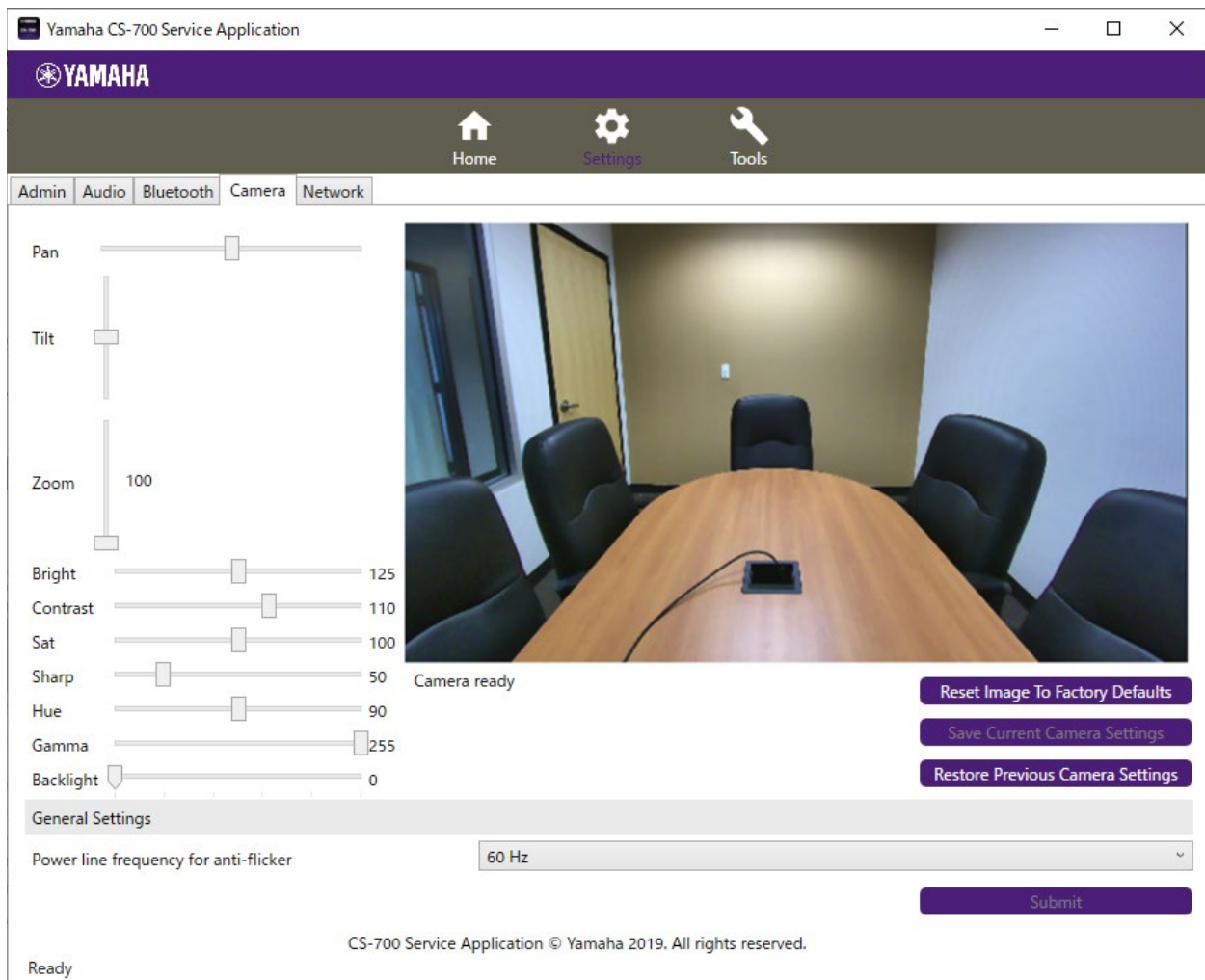

The screenshot displays the Yamaha CS-700 Service Application interface. At the top, there is a navigation bar with icons for Home, Settings, and Tools. Below this, a tabbed menu shows 'Admin', 'Audio', 'Bluetooth', 'Camera', and 'Network', with 'Camera' currently selected. The main area is divided into two sections: a settings panel on the left and a live camera feed on the right. The settings panel includes sliders for Pan, Tilt, Zoom (set to 100), Bright (125), Contrast (110), Sat (100), Sharp (50), Hue (90), Gamma (255), and Backlight (0). The live camera feed shows a conference room with a long wooden table and several black chairs. Below the feed, there are three buttons: 'Reset Image To Factory Defaults', 'Save Current Camera Settings', and 'Restore Previous Camera Settings'. At the bottom of the settings panel, there is a 'General Settings' section with a dropdown menu for 'Power line frequency for anti-flicker' set to '60 Hz'. A 'Submit' button is located at the bottom right of the settings panel. The status bar at the bottom left shows 'Ready' and the bottom center shows 'CS-700 Service Application © Yamaha 2019. All rights reserved.'



## Network

The Network section allows specifying the IP configuration for the CS-700. Factory default, the device is set to DHCP enabled and no further IP settings are required. However, if a static IP address is to be assigned, “Enable DHCP” needs to be unchecked, and the static IP parameters can be provided.

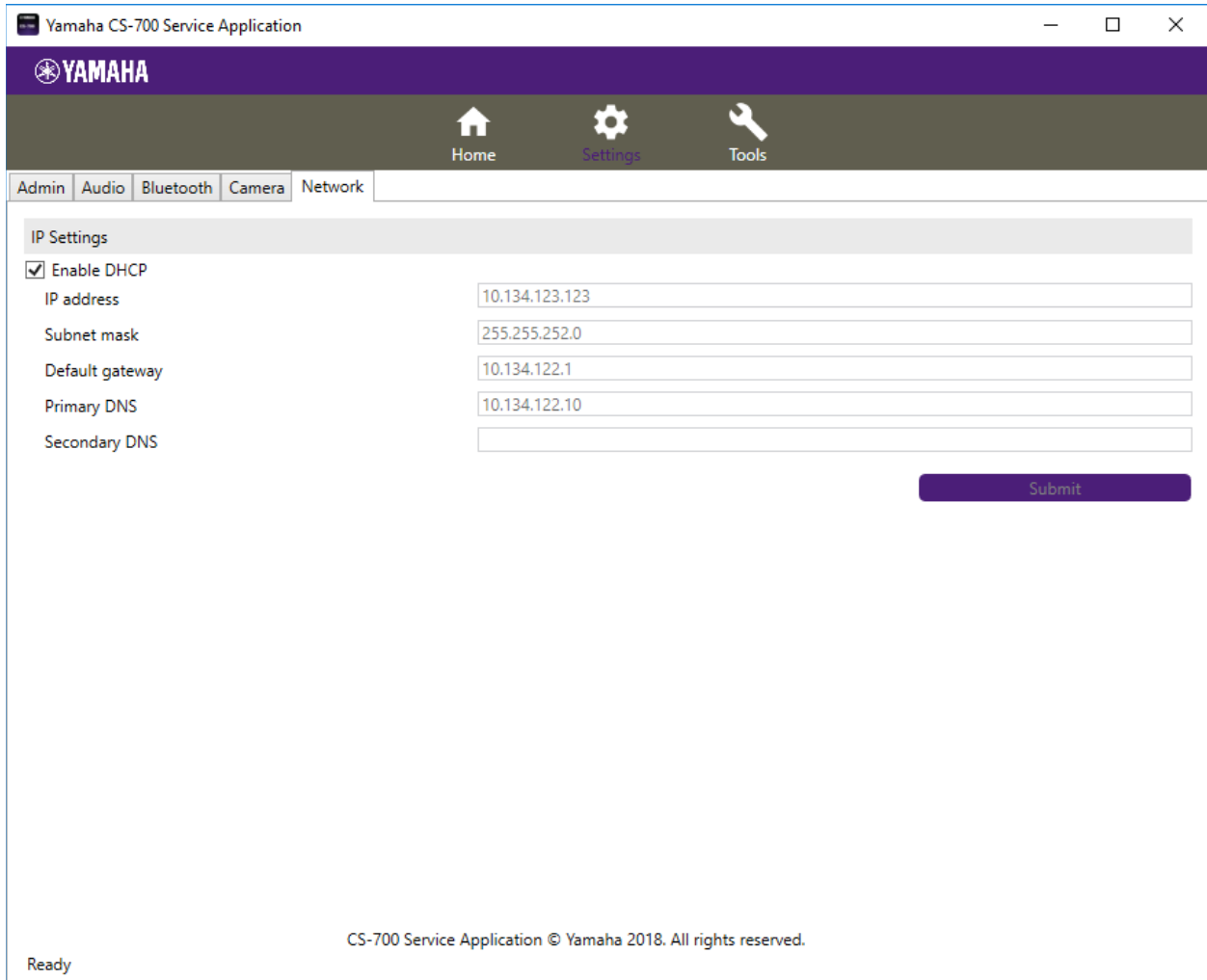

The screenshot shows the Yamaha CS-700 Service Application interface. The title bar reads "Yamaha CS-700 Service Application". The main header features the Yamaha logo and navigation icons for Home, Settings, and Tools. Below the header is a menu with tabs for Admin, Audio, Bluetooth, Camera, and Network. The Network tab is active, displaying the "IP Settings" section. This section includes a checked checkbox for "Enable DHCP" and five input fields for static IP configuration: IP address (10.134.123.123), Subnet mask (255.255.252.0), Default gateway (10.134.122.1), Primary DNS (10.134.122.10), and Secondary DNS (empty). A purple "Submit" button is located at the bottom right of the form. At the bottom of the application window, the text "Ready" is on the left and "CS-700 Service Application © Yamaha 2018. All rights reserved." is on the right.

IP Settings	
<input checked="" type="checkbox"/> Enable DHCP	
IP address	10.134.123.123
Subnet mask	255.255.252.0
Default gateway	10.134.122.1
Primary DNS	10.134.122.10
Secondary DNS	

Submit

Ready

CS-700 Service Application © Yamaha 2018. All rights reserved.

## Update

The update section allows updating the firmware of the Yamaha CS-700. After clicking on “Select firmware” browse to the location where the firmware file is being stored and select it.

Uploading the firmware file using USB will take several minutes, a progress indicator is shown on the bottom of the screen. During the upgrade process, the device will restart automatically. Once the boot-up chime sounds, the upgrade is completed. Give the unit several minutes to update all components and wait for the boot-up chime sound.

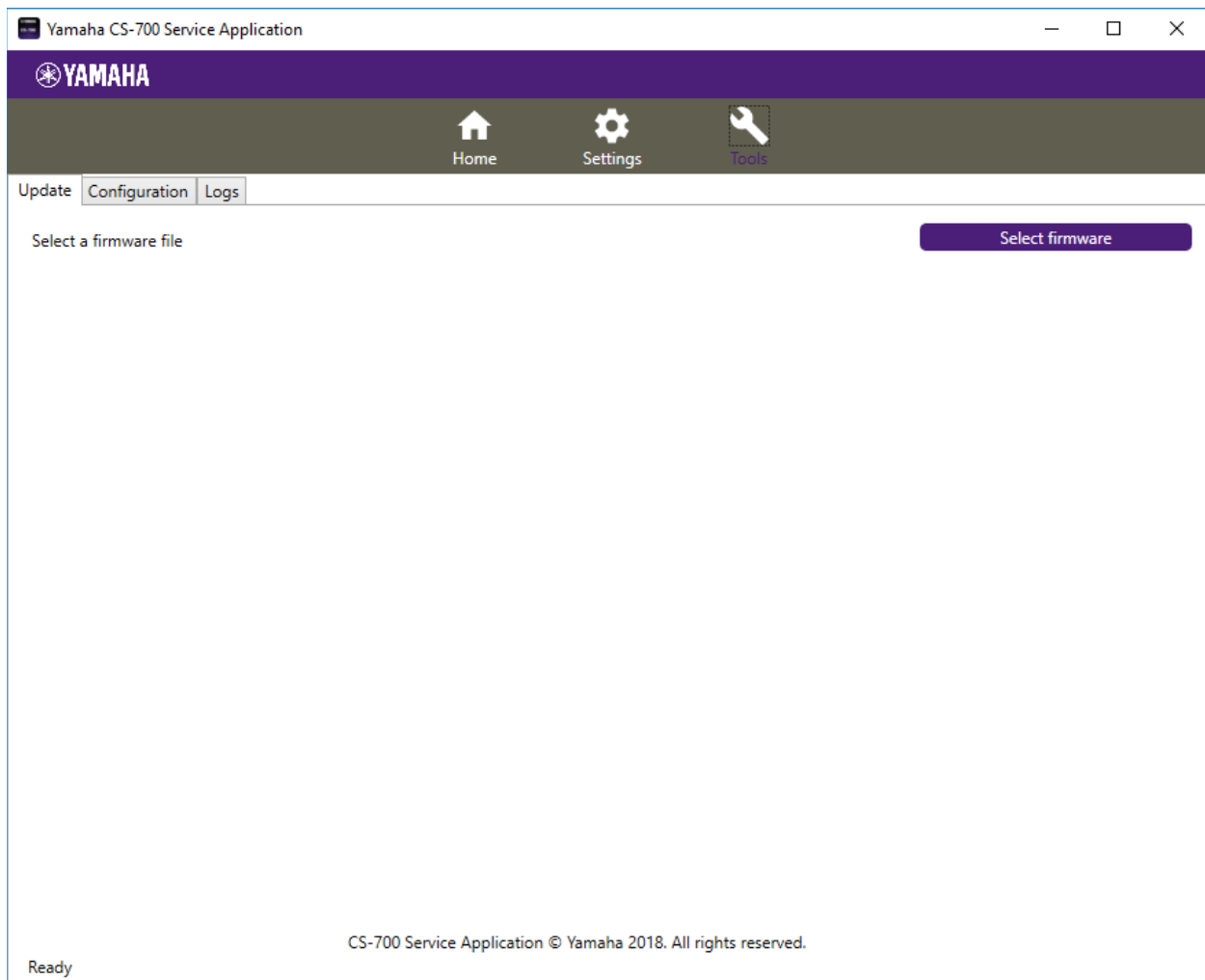

## Configuration

The configuration tab allows Exporting and Importing configuration information of the CS-700. This is specifically of interest if several CS-700 devices are to share identical configurations. The first CS-700 can be fully configured and exported as a “Golden Reference” configuration for the rest of the CS-700 estate. Subsequent CS-700 units can “duplicate” the Golden Configuration by re-Importing the original configuration file. For a description of the configuration parameters, see the provisioning section further down in this manual.

System defaults can be restored in a granular way by selecting which settings of the configuration to reset to defaults and then clicking the “Reset Defaults” button. Restore Factory Defaults restores all settings back to the original settings.

Selecting Restart will reboot the product.

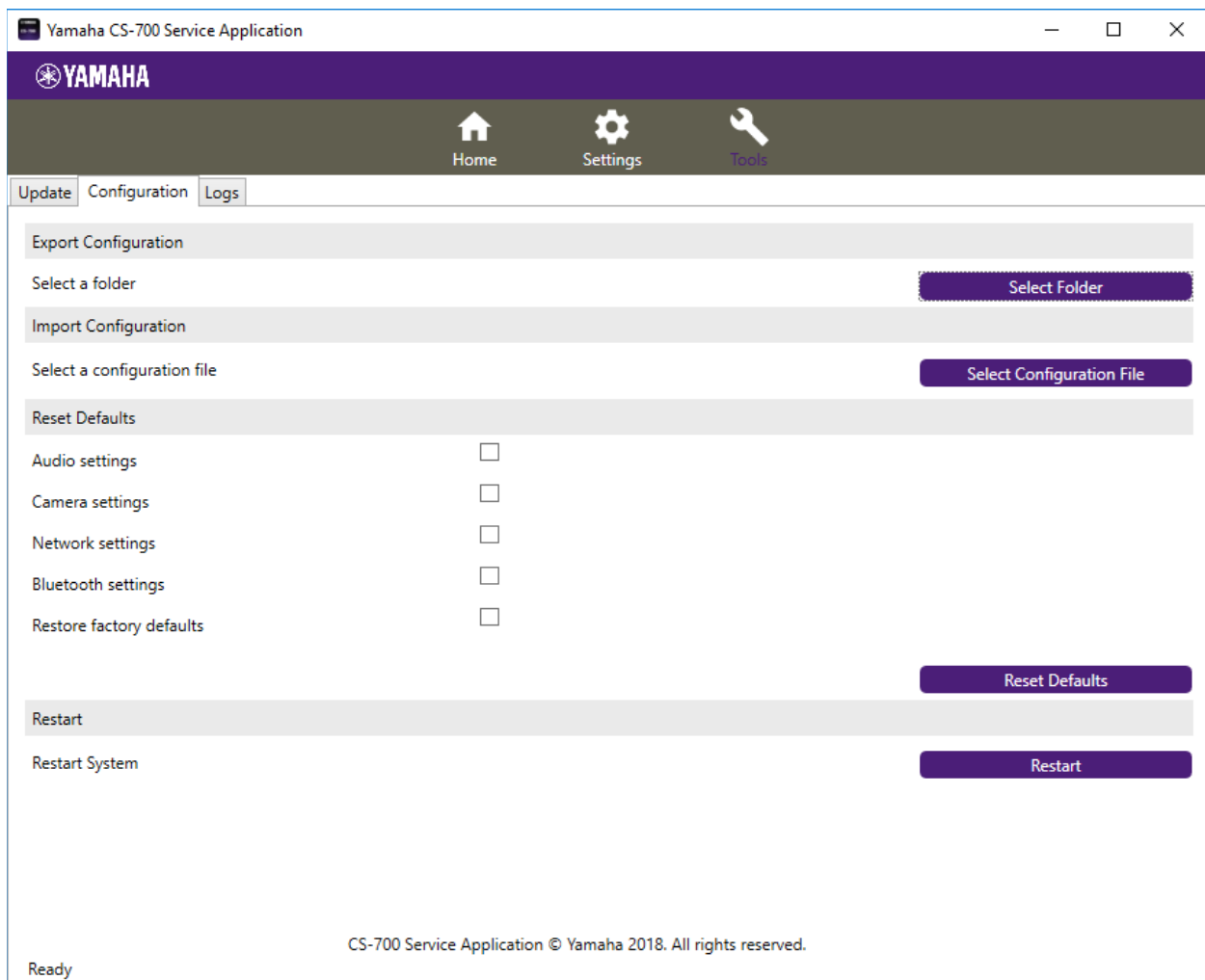

## Logs

The Logs section allows downloading logging information from the CS-700 for analysis. Access to logging information is typically only required when environmental issues with connected USB devices are experienced, and usually are shared with Yamaha Customer Support.

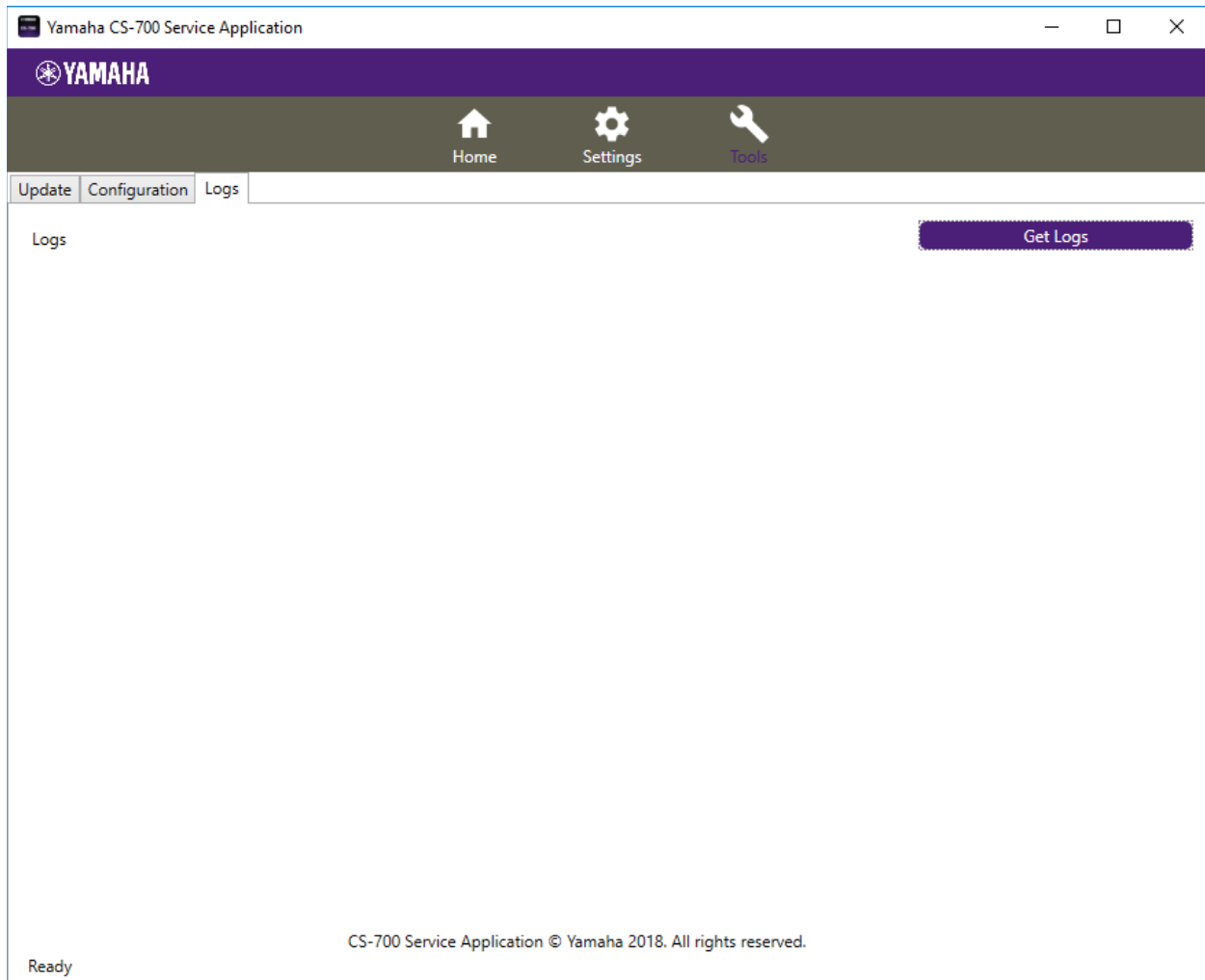

## Camera Control Application

To allow controlling the CS-700 camera's Pan, Tilt and Zoom setting, Yamaha provides the Camera Control Application. The Service Application also enables the camera settings, but this Camera Control Application is designed for end-users and does not require the admin password to use.

## Installation & Configuration

For installation, download the Camera Control Application installer from <https://uc.yamaha.com/products/video-sound-bar/huddle-room-system/>.

Running the installer application, it first asks you to accept the license agreement. Please read the agreement and if you accept the terms, indicate this below and continue with the installation. If you do not agree with the terms of the license agreement, please cancel the installation process and delete all copies of the installer application.

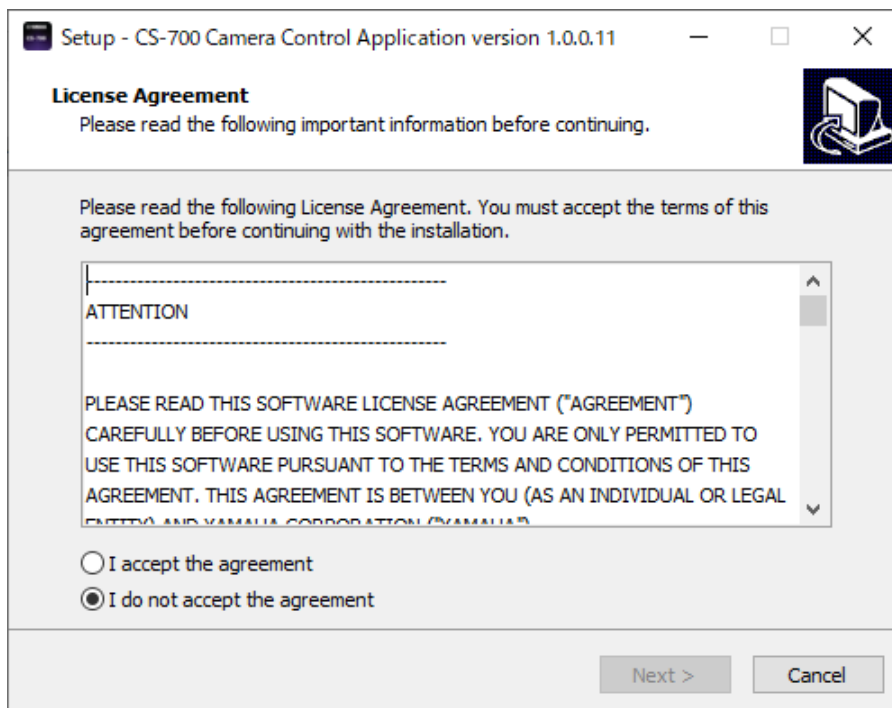

On the next screen select if a desktop shortcut is required:

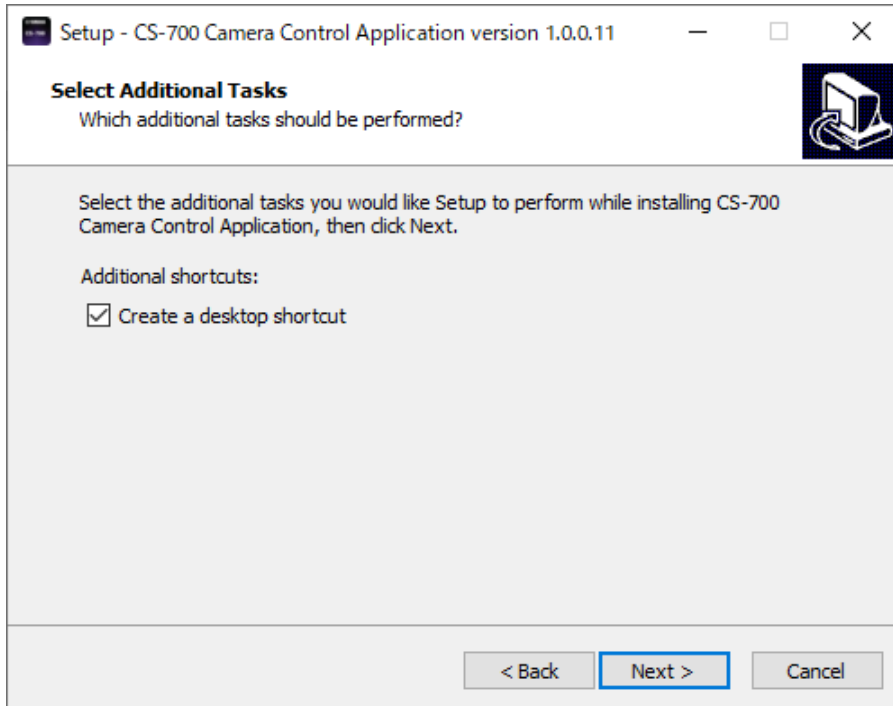

Finally, please confirm the selections and start the installation process.

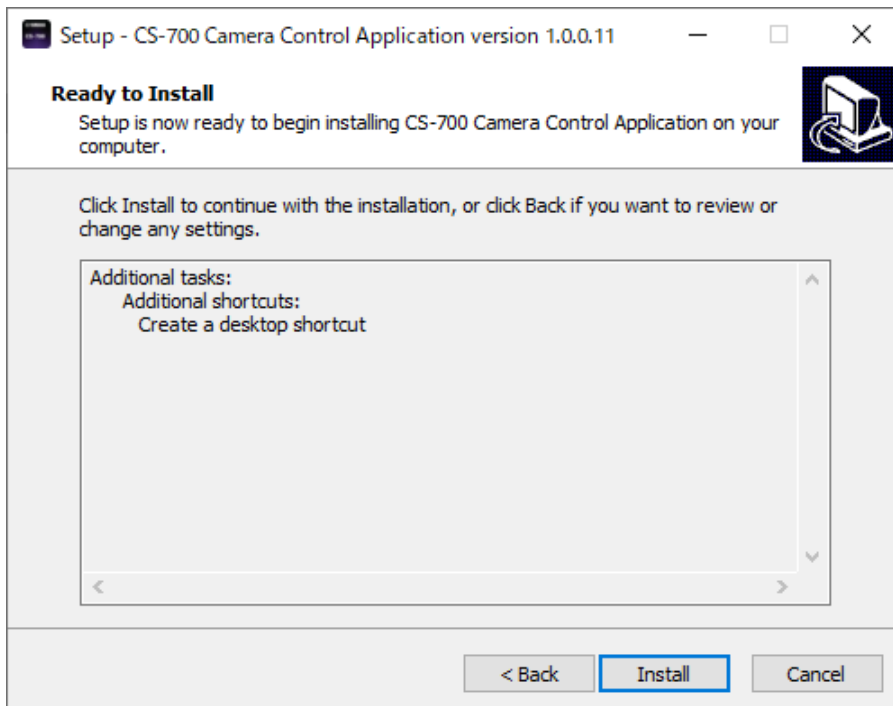

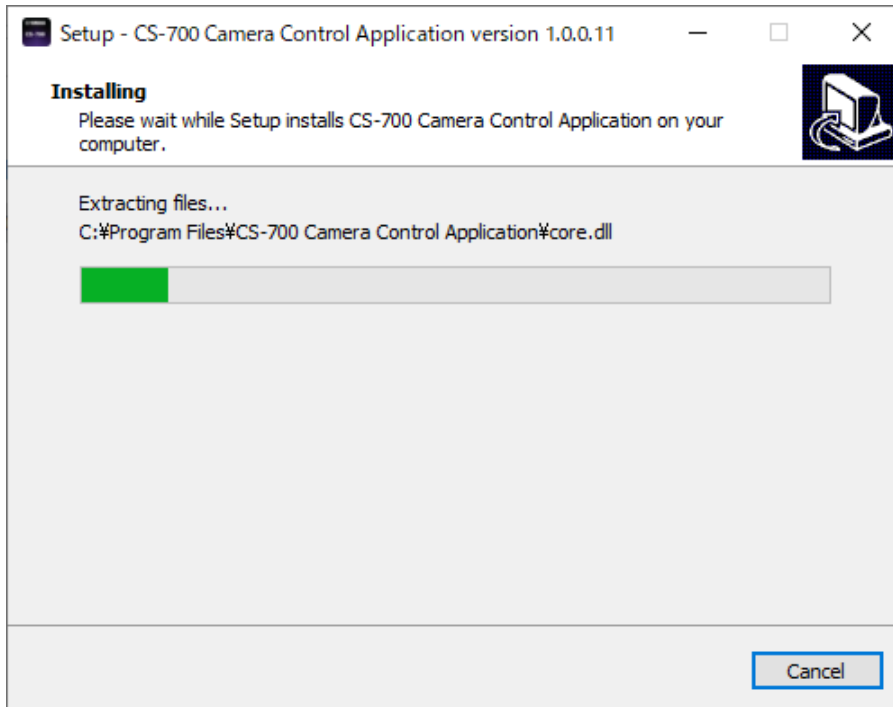

The Camera Control Application requires an additional device driver for the USB interface which requires confirmation:

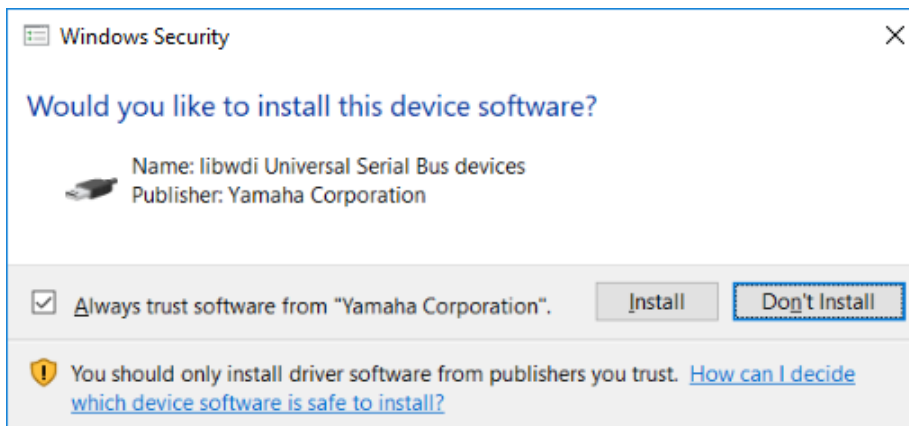

Finally, a window with help information is provided.

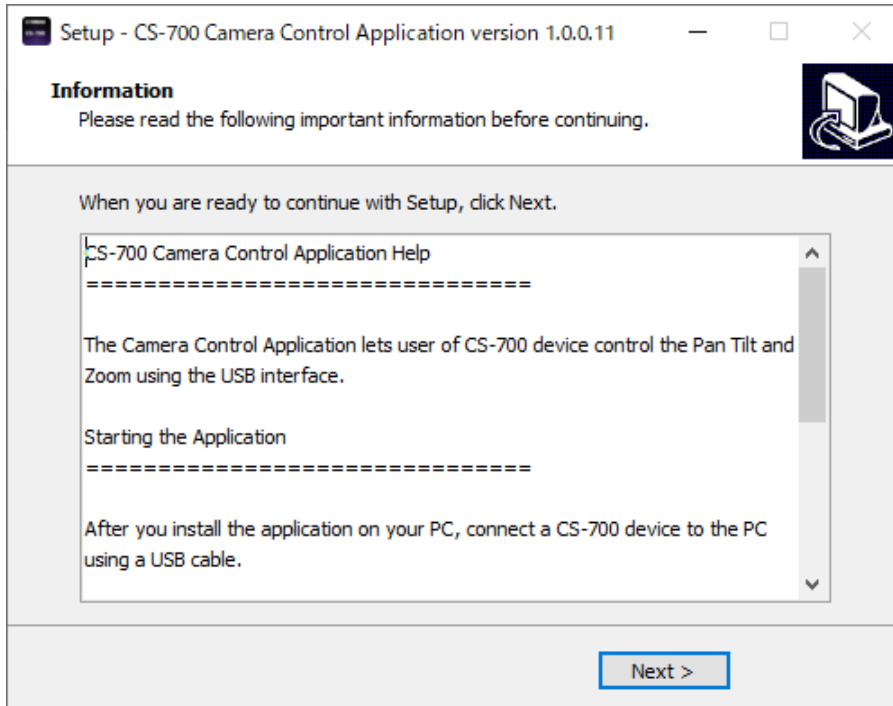

And lastly, the installation process provides a success message after a successful installation.

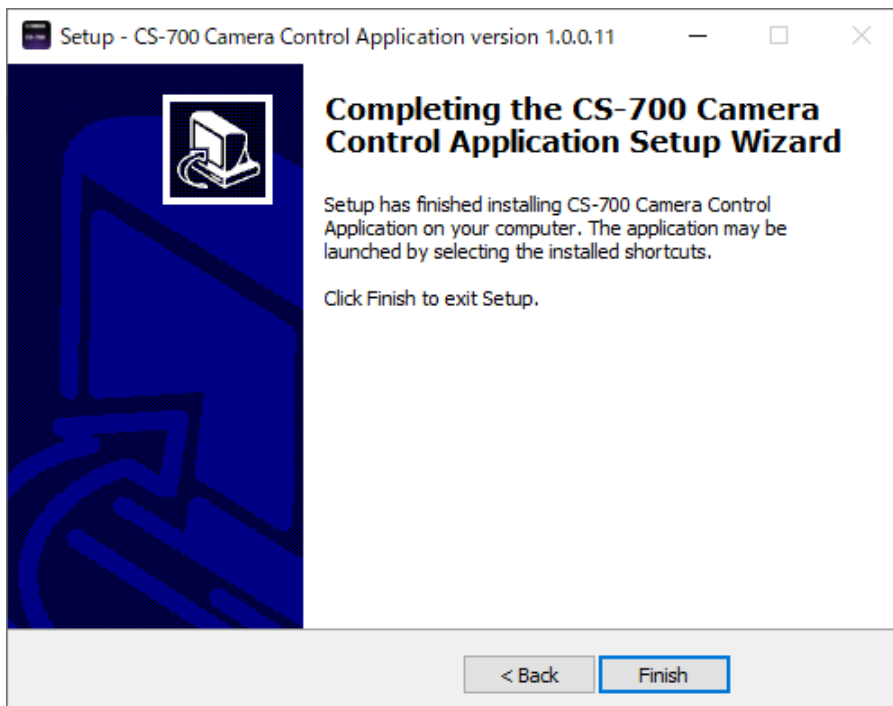



## Using the Camera Control Application

The Camera Control Application allows invoking the electronic Pan/Tilt/Zoom settings of the CS-700. Pan and Tilt will only work when the camera has zoomed in. Zoom values are from 100 – 400, Tilt from -18 to +18, Pan from -30 to +30. At the maximum zoom of 400, the camera offers a 36 degree field of view.

When the camera is used in another application, the preview image will not be shown. Once the other application using the camera is closed, clicking Reconnect will show the preview image.

Clicking PTZ Home will restore the camera to the stored PTZ home values.

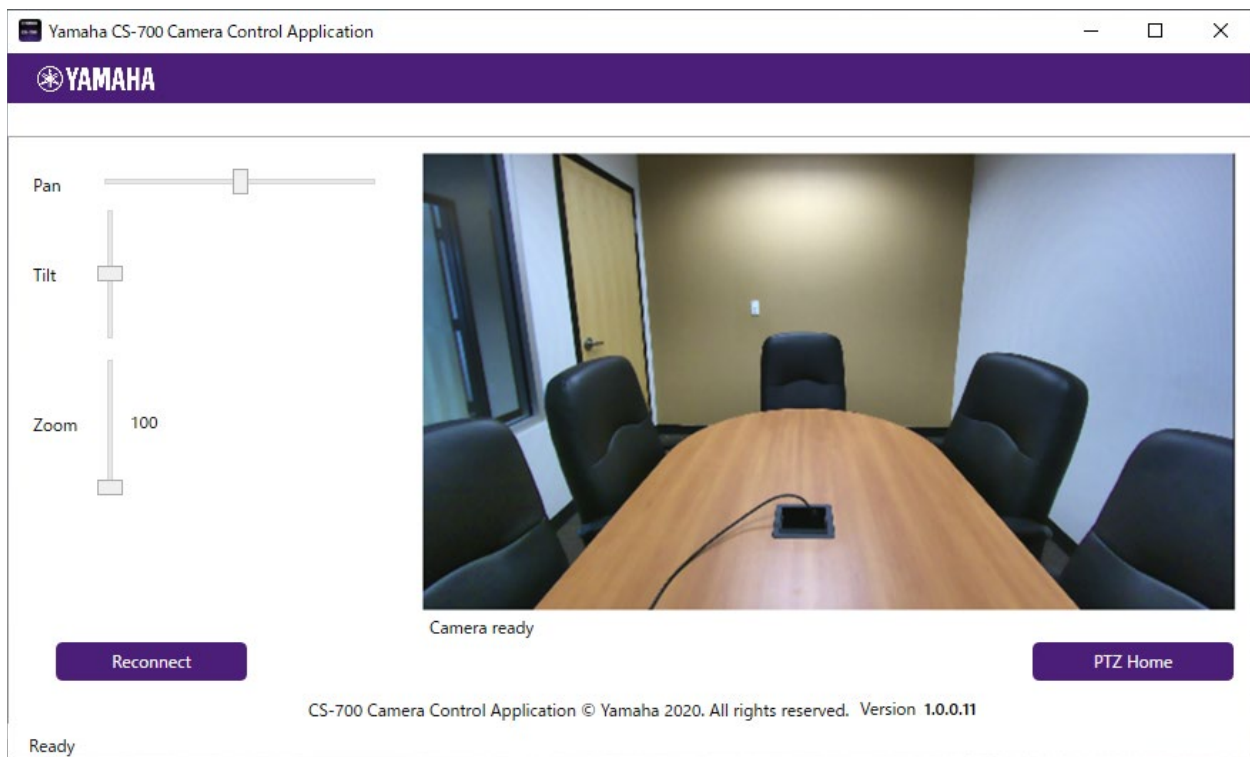

## Dialer Application

To allow managing SIP and USB calls in the SIP versions of the product, Yamaha provides an Android application. This Android app transforms a IP Wired or wireless tablet into a wireless “dialer” for the CS-700.

## Supported Tablets

The minimum Operating System version required is Android 5.1.

## Dialer application

To install the dialer application on the tablet, the tablet needs to be connected to the network. The dialer application should be installed as a full screen home application.

## Installing the dialer application

On the Google Play Store search for the “Yamaha Unified Communications CS-700 Dialer” Application. Follow the instructions to install the application on the tablet.

The dialer application should now start on the tablet. If it does not automatically start, please find the application in the list of available application, and start it.

In the application, input the IP address of the CS-700.

Allow a few seconds for the dialer to connect to the unit and download data.

The dialer is now ready for use.

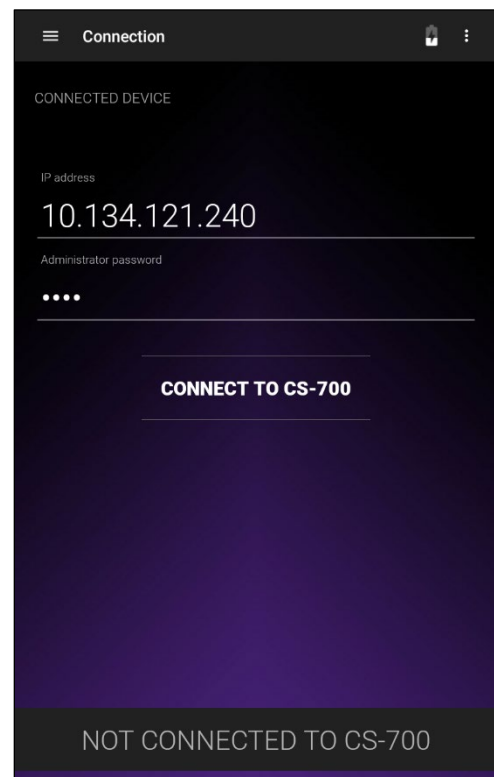

## Dialer interface

### Home screen

A dialer connected to a CS-700 will show the home screen. When not in a call, the center of the screen shows information on the Product, gives time and date information, and shows the telephone number under which the system is registered.

Selecting the large handset image or the number pad layout on the bottom left will open the dial-pad to start a phone call.

“Contacts” opens the list of contacts stored on the CS-700, “Recent” will open the list of recent calls made or received on the CS-700. Do Not Disturb will place the CS-700 in that mode and not allow calls to go through.

The microphone symbol on the bottom indicates the microphone mute status of the CS-700. Touching this symbol will toggle between unmuted (green) and muted (red). The other symbols on the bottom indicate the current call state for the SIP lines, the USB connection, and Bluetooth. Grayed out means that the connection is inactive, green means it is active, and orange means it is on hold.

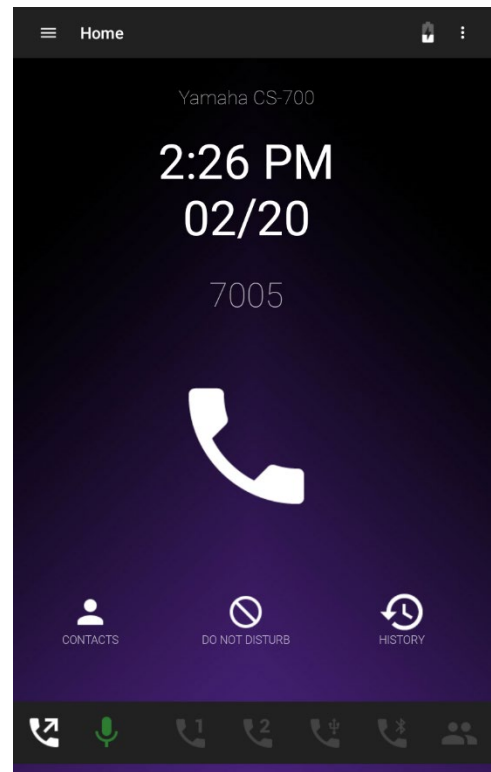

## Main Menu

Pressing the top left of the application screen will open the menu. It shows information on the dialer software version, the connection that is used between the dialer and the CS-700, and the name of the CS-700 system if it is connected wirelessly.

Below that the menu offers options to go back to the home screen, open the dial pad, open the contact list, review the history, open the Bluetooth or USB connection information, or change settings.

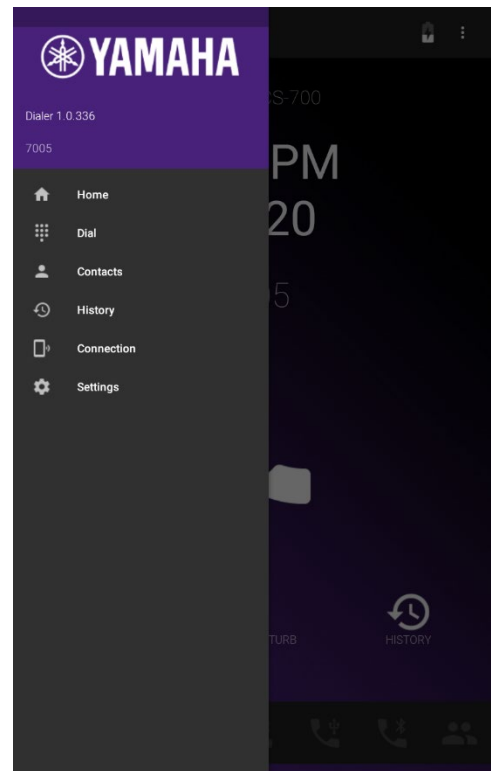

## Contacts

When selecting “Contacts”, an alphabetic list of the contacts stored on the CS-700 will be displayed. Selecting any of the names will open the contact. Pressing the symbol with the “+” in the top right will open a new contact. The CS-700 can store up to 100 contacts.

Each contact can have three numbers associated with it (Mobile, Work, Home), of which one can be selected as the “default” number. This number will be used when using search by name in the dialing page. See the section on Dialing and call control on page 80 for more details.

In an open contact, selecting either the name or any of the numbers will enable editing functionality, opening a keyboard on the screen. Changes must be saved by selecting the floppy-disk symbol on the bottom of the page.

To delete a contact, open the contact and select the menu on the top right of the screen – the option to delete the contact will be provided.

To dial a contact, simply press on the phone symbol next to the number that should be dialed. The phone number will be automatically called.

The contact list can be searched by typing in a search string in the magnifying glass area. The search is done against the stored name, and shows matches against any part of the name string.

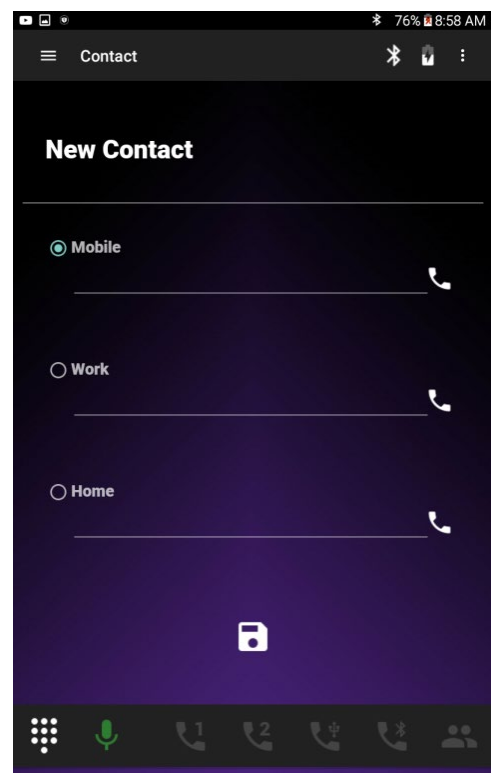
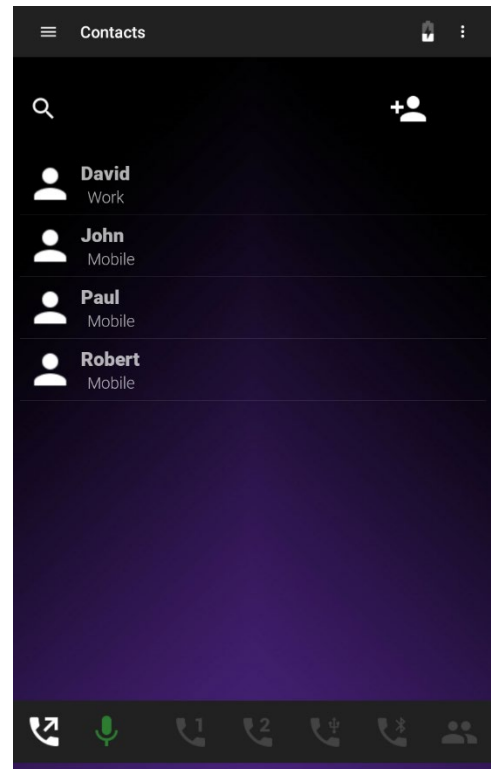

## Call History

The call history page lists a history of the last 100 incoming, outgoing calls, failed, and missed calls.

The call history can be searched by typing in a search string in the magnifying glass area. The search is done against the telephone number or the stored name of a contact, and shows any matches against the search string.

Depending on whether an entry in the list is also in the Contact or not, the user will either be offered to change the existing contact, or add the number into a new contact, respectively.

The menu on the top right allows to filter the view of the call history, by selecting incoming, outgoing, missed, or failed calls only. Entries can also be deleted – either delete all, delete duplicate entries, or a single selected entry can be deleted.

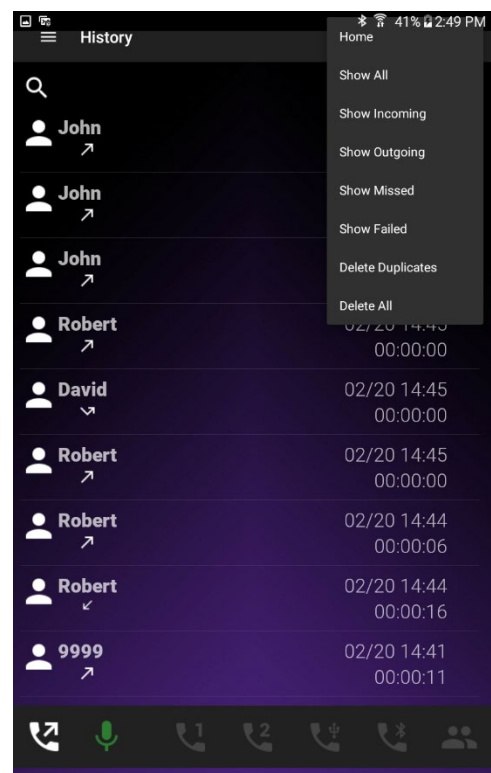
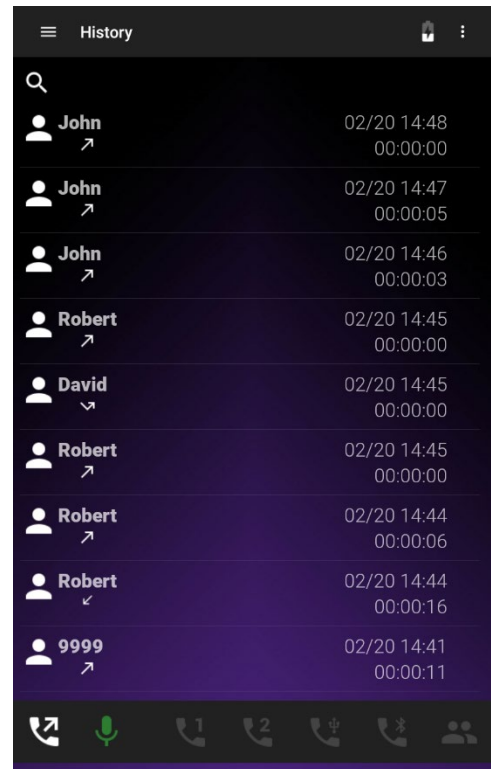

## Connection

The menu entries provide information on the connection to the CS-700.

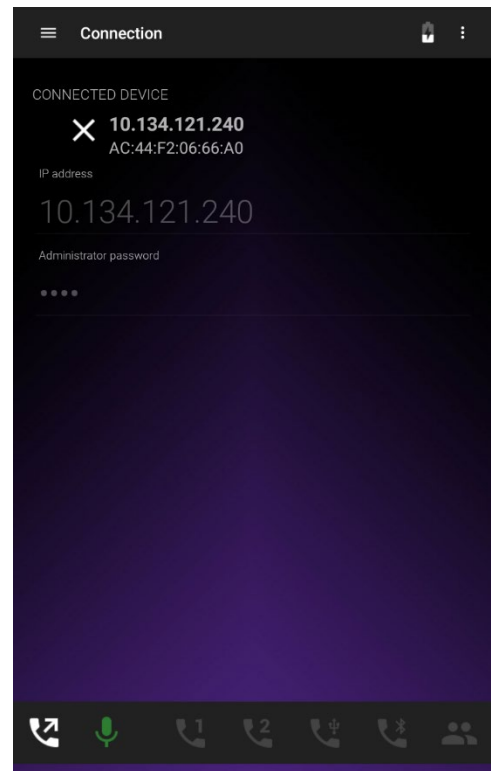

## Settings

The Settings menu allows changing the volume for the ringer as well as the speaker output during a call. It also allows changing the brightness of the dialer LCD-screen.

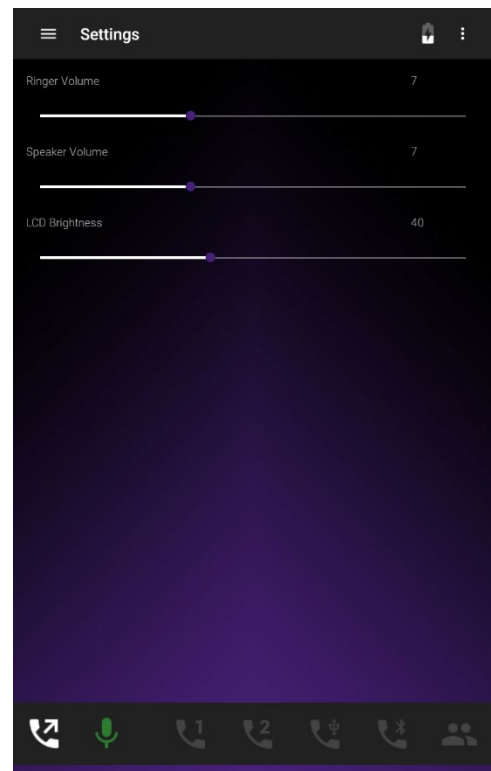

## Dialing and call control

The dialer is designed to manage telephone calls as well as USB and Bluetooth connections. It allows establishing calls, controlling calls, and mixing calls together to create conferences.

As mentioned earlier, the bottom line of the dialer indicates activity of the different supported communication channels. Generally, if a USB cable is connected to the CS-700 and activity is being detected, the USB line is active. If no activity is detected, the symbol will be greyed out. Similarly, when a Bluetooth call is detected, the Bluetooth symbol will show activity.

When talking about a “call” in this section, this can mean a USB connection, a VoIP call, or a Bluetooth call.

### Dialing

To start a call, select “Dial” from the main menu, touch the key-pad symbol on the bottom, or touch the green phone symbol on the main screen. The keypad will open allowing the user to type in the phone number for the call and establish the call by pressing the green call button. The screen will change and showing the outgoing call activity until the call is established.

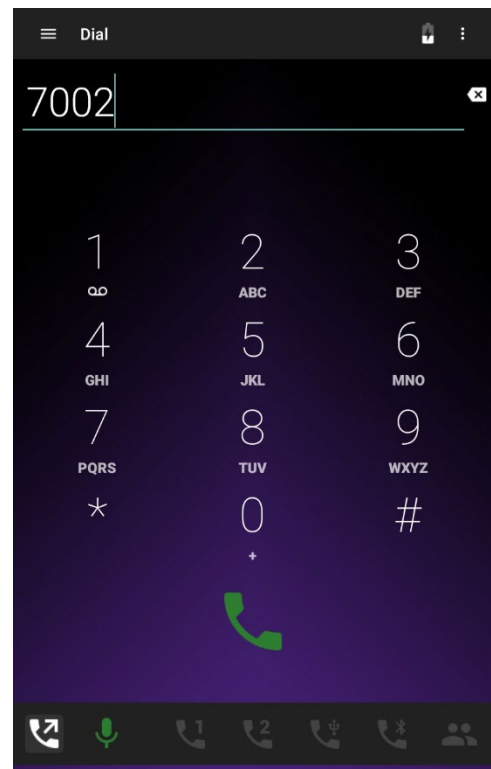



### **Active call**

Once the call is established, the dialer screen will change to an informal screen with call information. The active call with the telephone number or contact name that was called is shown, with the call duration. There are also call control and audio control buttons.

For audio control, the volume up and volume down button on the dialer screen are synchronized with the CS-700 audio behavior. The microphone mute button on the bottom is also synchronized with the mute behavior of the CS-700.

Touching the red phone symbol will end the call.

The SIP phone line that is active with the call is shown as active (green) on the bottom of the dialer screen.

Touching the hold symbol will put the call on hold, touching join allows creating a conference with other active audio streams.

To enter digits during the call, touch the dial-pad symbol on the bottom to open the dial pad and enter the digits.

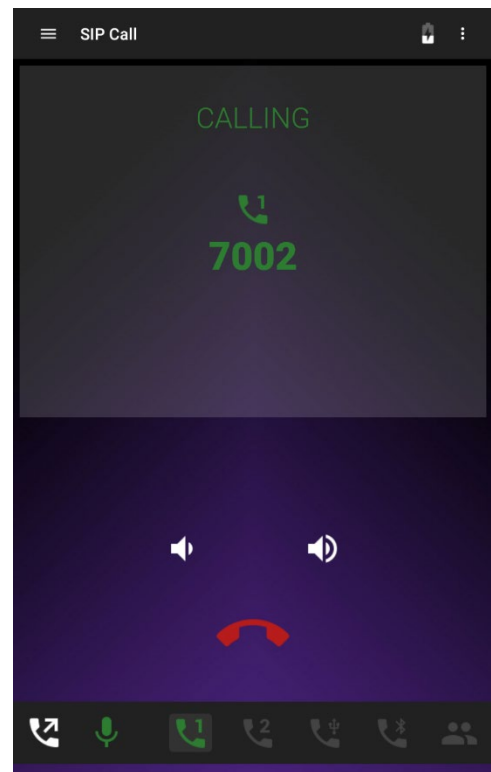

### ***Incoming call***

An incoming call is indicated by a blue symbol on the bottom line. The screen changes to indicate the incoming call. Ongoing calls are not interrupted unless the call is accepted. The call can be accepted, rejected, or directly joined into an ongoing call or conference.

To accept the call, touch the green handset symbol. Once the call is accepted it becomes the active calls, previously active calls will be put on hold.

To reject the incoming call press the red handset symbol.

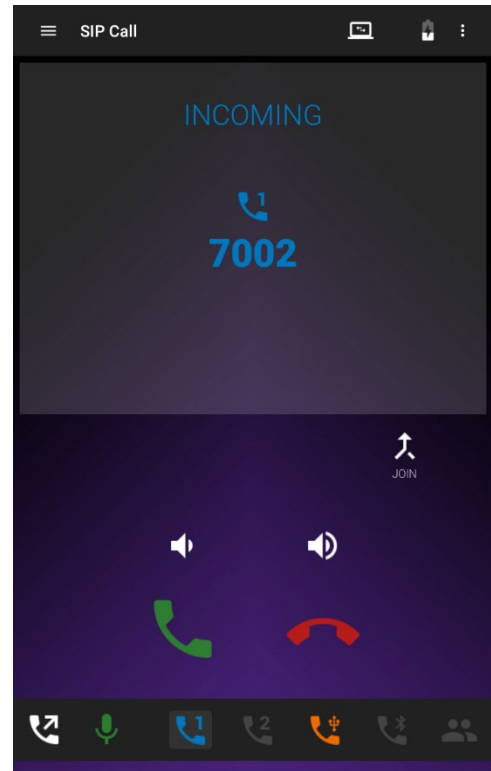

### ***Switching active call***

When several calls are handled by the CS-700 concurrently, the user can switch between the calls by simply selecting and touching the entry for the call on the dialer display. Calls not selected will not be active and put on hold.

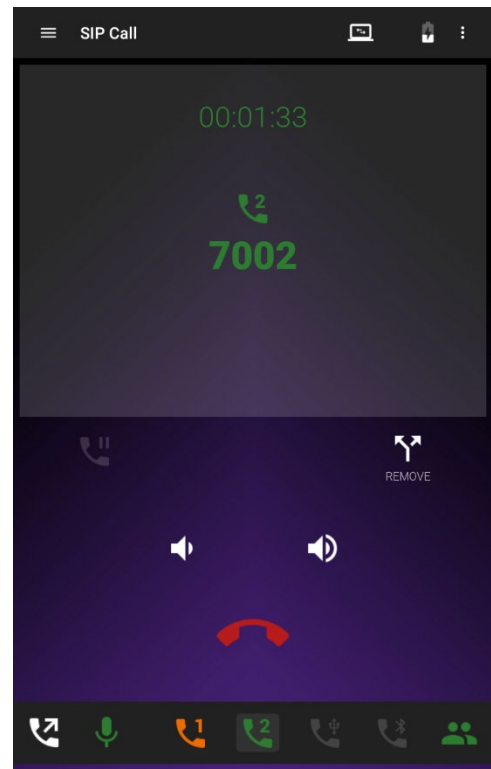

### **Conference call**

All call instances handled by the CS-700 can be placed into conference with each other. If calls are already established (and on hold) they can join the active call by pressing the “join” button. Similarly, a call can be taken out of a conference by pressing “split”.

Note: When the CS-700 system that manages the conference is muted, this might affect audio flow to the party participating on the USB connection. If the UC application synchronizes its mute, it might not accept any more audio from the UC application. VoIP and Bluetooth call audio would no longer be delivered to the USB connection.

### **Dial a Contact or redial a previous number**

A Contact or a recent number can be dialed from the respective menus by selecting the dialing options in these menus.

### **Failed Call**

If an outbound call failed, the dialer screen will provide that information, and allow for an easy re-dial option by pressing the green handset symbol.

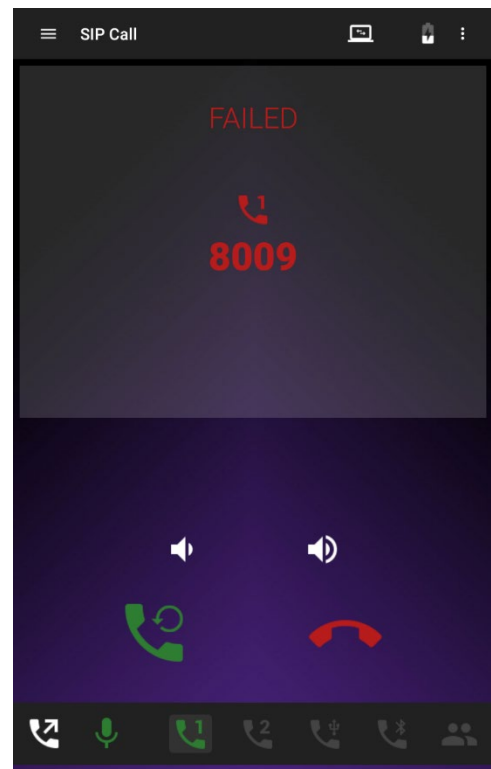
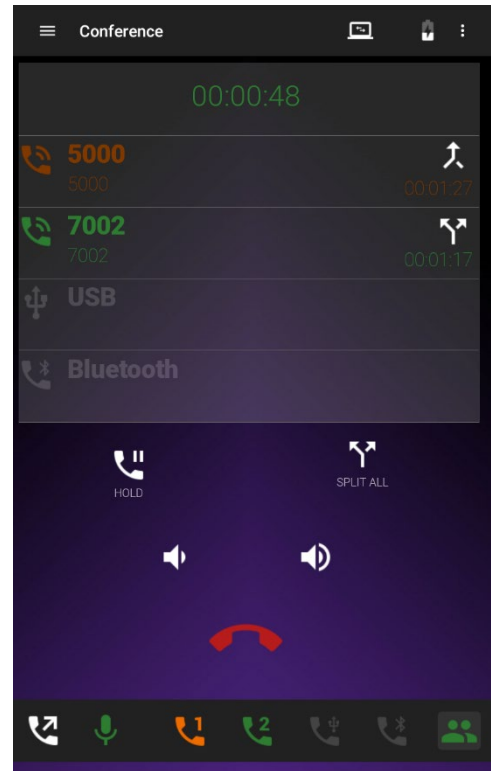

### ***USB and Bluetooth calls***

USB and Bluetooth calls will provide a similar user experience to VoIP calls on the dialer. Users will have similar controls for Bluetooth and USB calls as are provided for the VoIP calls.

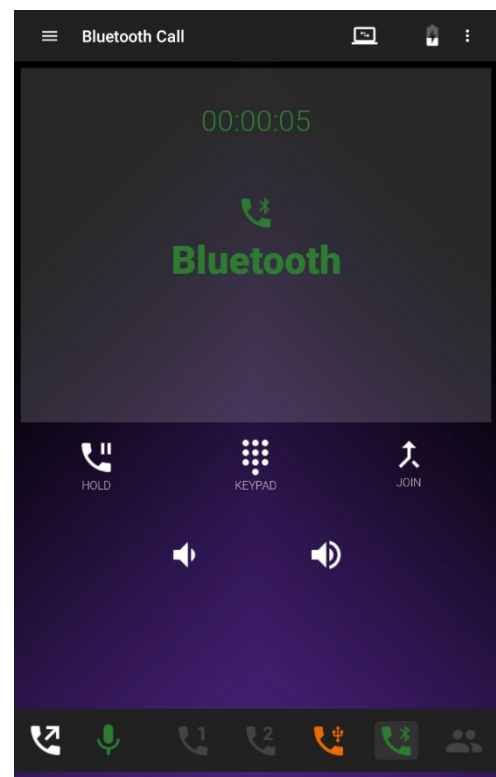
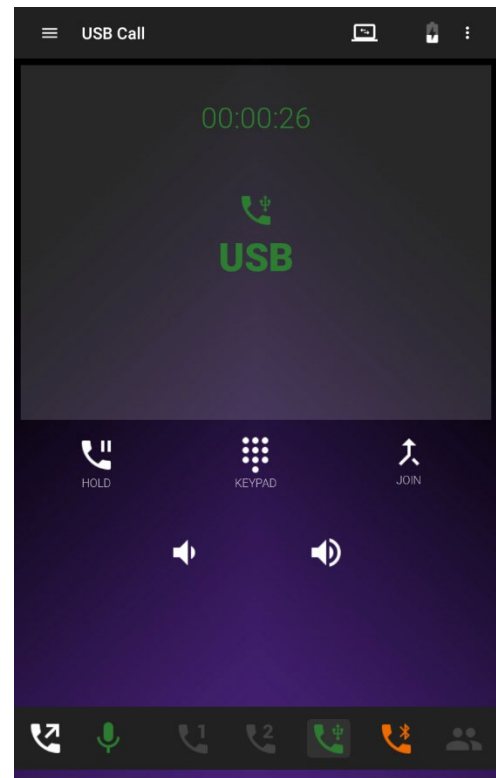

## **Basic Operations**

### **USB Connected Video Conferencing – BYOD (Bring Your Own Device)**

1. To use the CS-700 with popular Unified Communications (UC) Software, connect your Computer to the CS-700 main USB cable using a USB 3.0 compatible port, and select the Yamaha CS-700 Audio Device and Yamaha CS-700 Camera on your Computer.
2. Log-in to the UC Software and establish the video conference session.
3. Adjustments to volume can be made through the Computer Operating System or directly on the CS-700 front panel.
4. Adjustments to camera settings such as contrast and brightness can be made through the UC software configuration menus.

### **USB Connected Video Conferencing – DIR (Device in Room)**

To use the CS-700 with a permanently connected device in the conference room, follow the instructions described above in the BYOD section, points 2 through 4. The organization's IT department will pre-load the installed computer as required during the installation process.

### **Controlling the Video Image**

Some Unified Communication (UC) applications do support changing camera settings. The CS-700 does support several of these settings like pan, tilt, and zoom, but also brightness, contrast, backlight compensation, and others.

When changing any of these settings using the UC application, the CS-700 will return to its factory default values and “PTZ Home” settings once the USB connection is interrupted. A new user entering the room to use the CS-700 will find the system back with the preset values.

### **Bluetooth Pairing and Activation**

Press the Bluetooth button on the CS-700 front panel and hold until it flashes blue, indicating that pairing mode has begun. Once in pairing mode, accept the pairing request from “Yamaha CS-700 <mac address>” (or the name assigned by the System Administrator) as indicated on your hand-held device. Once pairing completes, the Bluetooth key on CS-700 will glow steady blue, indicating an active Bluetooth connection is present.

At this point, audio from the Bluetooth connected device will be redirected onto the CS-700 speakers, and automatically mixed with other audio sources connected to CS-700, such as USB-based audio. Audio in from the MIC array will be redirected to the mobile device.

The Bluetooth connection will remain engaged until any of several actions occurs:

- The User deactivates the connection from the mobile device.
- The User moves out of range of the Bluetooth signal.
- The User ceases to transfer data over the connection, and a connection timeout occurs.

Note: the connection timeout is a configurable parameter, set either through Web-UI or a configuration file. When set to 0, the connection will never drop from data inactivity.

## **Aux-IN Audio Support**

To utilize the CS-700 as a room speaker system such as for the display in TV mode, connect your source of audio via a standard 3.5mm stereo jack connector on the back of the unit. Gain is automatically adjusted by default and the Volume Up/Down controls will manage the sound level. Gain can be manually set as well, configurable through the Web-UI, the Service Application, or from a configuration file.

## **Configuring the CS-700**

This section will provide details on how to configure the CS-700 device. The information provided here is general and provides the details of how to access the configuration settings on the CS-700 and to enter in specific information.

There are three methods to configure the CS-700: from the Web UI over IP network, using the Service Application on a local USB-attached PC, or using a provisioning server and provisioning file with DHCP Option 66 or 150.

### **Configuring using the Web User Interface**

Refer to the Web-UI description section and follow through all required configuration menus to achieve the desired configuration result. Be sure to “Submit” each configuration change before moving to another menu page, or settings will be lost.

Once all desired configuration changes have been made and submitted, take the time to export the system configuration to an external file for future use, either to restore the current unit or to provide a baseline configuration for other units in your installation.

It is recommended to reboot the device once all configuration changes have been performed.

### **Configuring using the Service Application**

Refer to the Service Application description section and follow through all configuration menus to achieve the desired results.

It is recommended to reboot the device once all configuration changes have been performed.

### **Configuring using a Provisioning Server, Option 66**

Option 66 allows IP Devices to download their configuration from a TFTP server. When an enabled IP device boots, it sends a request to the DHCP server for an IP address. In addition to the IP address, the DHCP server sends additional information back to the device as configured on the DHCP server. Option 66 is a configuration item that allows providing the address or hostname of a TFTP, FTP, or HTTP server to the device.

An HTTP server needs to be configured as

http://<server address>

An FTP/TFTP server needs to be configured as

ftp://<server address>/user="<username>"&pass="<password>"

where <username> and <password> are the username and password required to access a TFTP server.

Once the CS-700 receives the address information of that server, it tries to access configuration files on that server to auto-configure the device during start-up. The configuration file for the specific CS-700 device needs to be named <MAC-address of device>.xml.

Any configuration data provided from the configuration files will overwrite configuration settings that might have been entered in the CS-700 previously.

A list of the available parameters with a short description is provided further down in this manual. A set of sample configuration files is also provided.

## **Configuring using a Provisioning Server, Option 150**

Option 150 allows IP Devices to download their configuration from a list of TFTP servers. When an IP device starts, it sends a request to the DHCP server for an IP address. In addition to the IP address, the DHCP server sends additional information back to the device as configured on the DHCP server. Option 150 is a configuration item that allows providing a list of addresses or hostnames of TFTP, FTP or HTTP servers to the device.

HTTP servers needs to be configured as

http://<server address>

FTP / TFTP servers need to be configured as

ftp://<server address>/user="<username>"&pass="<password>"

where <username> and <password> are the username and password required to access the TFTP server.

Once the CS-700 receives the address information of these servers, the device will try to access configuration files on these servers to auto-configure the device during start-up. The configuration file for the specific CS-700 device needs to be named <MAC-address of CS-700>.xml.



Any configuration data provided from the configuration files will overwrite configuration that might have been entered in the phone previously.

## Provisioning file

The provisioning file is in xml format. The syntax of the file is

```
<provisioning [include="{comma separated list of include files}"]>
    [<config {list of config parameters} />]
    [<firmware version="{firmware version}">{firmware file name}</firmware>]
</provisioning>
```

Where [] indicates an optional parameter and {} indicate a description of the content to be provided.

The “config” tag contains all configuration settings that pertain to the device, while the “firmware” tag includes the latest firmware version and firmware file name.

## Sample device configuration file

Filename: **F0DEF1A064E6.xml** for the unit with the MAC address F0:DE:F1:A0:64:E6. Please note that all letters need to be upper case in the file name.

```
<provisioning include="enterprise.xml, department.xml">
    <config
        sys.password="1234"
    />
</provisioning>
```

## Include files

Filename: **enterprise.xml**

```
<provisioning>
    <firmware version="1.4.0.6">CS700-1-4-0-6.bundle</firmware>
    <config
        audio.eq="1"
        audio.def-speaker-volume="5"
        audio.high-pass-filter="3"
    />
</provisioning>
```

Filename: **department.xml**

```
<provisioning>  
  <config  
    net.ntp1="0.pool.ntp.org"  
    net.ntp2="1.pool.ntp.org"  
    sys.provisioning-interval="1440"  
  />  
</provisioning>
```

## **Provisioning file parameters (All Models)**

The following table lists the attributes that can be provided as part of a provisioning file for CS-700, applicable to all models. If a specific attribute is not provided and the value is not set in the device, the default value as described will be used.

Property	Type	Values	Default Value	Description
sys.systemname	TEXT	System name string. Default value is the product name concatenated with the MAC address	Product name and MAC Address	Specifies the system name.
sys.md5-password	TEXT	Password string.	7386 (as MD5 sum)	Administrator password for the device, stored as MD5 sum.
sys.enable-btn-camera	BOOLEAN	0 : Disable button 1 : Enable button	1	Enable/disable the camera button on the main unit.
sys.enable-btn-audio	BOOLEAN	0 : Disable button 1 : Enable button	1	Enable/disable the microphone mute button on the main unit.
sys.enable-btn-volume	BOOLEAN	0 : Disable button 1 : Enable button	1	Enable/disable the speaker volume buttons on the main unit.
sys.enable-btn-bluetooth	BOOLEAN	0 : Disable button 1 : Enable button	1	Enable/disable the Bluetooth button on the main unit.
sys.enable-led-call	BOOLEAN	0 : Disable LED 1 : Enable LED	1	Enable/disable the call state LED on the main unit.

Property	Type	Values	Default Value	Description
sys.region	INDEXED_OPTION	1 : Argentina 2 : Australia 3 : Belgium 4 : Brazil 5 : Canada 6 : Chile 7 : China 8 : Costa Rica 9 : France 10 : Germany 11 : Hong Kong 12 : India 13 : Israel 14 : Italy 15 : Japan 16 : Malaysia 17 : Mexico 18 : New Zealand 19 : Singapore 20 : South Africa 21 : Taiwan 22 : United Kingdom 23 : USA 24 : Venezuela	23	Region in which device is operating, setting by index.
sys.require-https	BOOLEAN	0 : Do not require HTTPS 1 : Require HTTPS	0	Configure whether https is required.
sys.power-saving-mode	BOOLEAN	0 : Power save mode is off 1 : Power save mode is on	1	Configure the power saving mode setting.
sys.power-saving-time	NUMBER	timeout : Power save timeout in minutes	20	Configure power saving time in minutes. The maximum value is 480 minutes (8 hours).
sys.provisioning-interval	NUMBER	1..44640 : Provisioning interval in minutes	1440 (1 day)	Specify the provisioning interval for the device, in minutes. The maximum interval is 44640 (31 days).
sys.snmp-enable	BOOLEAN	0 : Disable SNMP 1 : Enable SNMP	0	Enable or disable SNMP support. Disabled (0) means that SNMP is not supported. Enabled (1) means that SNMP is available.

Property	Type	Values	Default Value	Description
sys.snmp-community	TEXT	Read-only community string.	public	Specifies the SNMP read-only community string used for queries from the server and transmitted traps. Read-only indicates the authorization level. The device does not support write operations initiated through SNMP.
sys.snmp-contact-name	TEXT	Contact name.		Specifies the contact name, typically the system administrator. This string is informational and can include an email address. It is not associated with traps.
sys.snmp-device-location	TEXT	Device location.		Specifies the location of the device for informational purposes.
sys.snmp-address	TEXT	IP address or DNS name.		Specifies the SNMP server address to which traps will be sent. Leave blank to disable traps.
sys.recent-call-enabled	BOOLEAN	0 : Disable recent call list 1 : Enable recent call list	1	Enables or disable the Recent Calls list.
sys.ui-mask	NUMBER	0 : All menus are enabled in the dialer 4 : Do not allow modifications of call forwarding 8 : Do not allow modifications of call history 16 : Do not allow modifications of contacts 32 : Do not allow modifications of DND	0	Enable or disable menus in dialer via a bit mask. Add the values of all features that are to be disabled. For example a value of 40 (8+32) will not allow modifications to the call history, and does not allow modification of the DND.
audio.eq	NUMBER	1 : Voice 2 : Bass boost 3 : Treble boost	1	EQ setting used to adjust the speaker frequencies to your preference for the room and the types of calls.
audio.high-pass-filter	INDEXED_OPTION	0 : None 1 : 110 Hz 2 : 140 Hz 3 : 175 Hz 4 : 225 Hz	0	High-Pass filter setting. High-Pass filters are provided to adjust to room and application requirements. Use the High-Pass filter in rooms that have a high background noise in the low frequencies (air conditioning, lighting fixtures, etc.). All filters are bi-quad filters, reducing the signal by 6dB per octave.
audio.analog-audio-in-mode	BOOLEAN	0 : Automatic gain setting 1 : Manually specify gain setting	0	For the audio in port, select the gain setting mode, either auto or manual.

Property	Type	Values	Default Value	Description
audio.analog-audio-in-gain	NUMBER	-12.0..40.0 : Manual gain setting	4.5	For the audio in port, if analog-audio-in-mode is set to manual, this parameter specifies the gain value in dB. This value can be increased or decreased in 0.5dB steps.
audio.wireless-omni-mic	BOOLEAN	0 : Disable wireless omni mic 1 : Enable wireless omni mic	0	Enable/disable additional audio processing for wireless omnidirectional microphone.
audio.wireless-direct-mic	BOOLEAN	0 : Disable wireless direct mic 1 : Enable wireless direct mic	0	Enable/disable additional audio processing for wireless directional microphone.
audio.wireless-lapel-mic	BOOLEAN	0 : Disable wireless lapel mic 1 : Enable wireless lapel mic	0	Enable/disable additional audio processing for wireless lapel microphone.
audio.ring-tone	INDEXED_OPTION	0..5 : Ring-tone index	0	VoIP ring-tone selection.
audio.ringer-volume	TEXT	1..18 : Ringer volume level	13	Configure VoIP ringer volume.
audio.speaker-volume	TEXT	1..18 : Speak volume level	13	Configure speaker volume for calls.
camera.camera-ptz-home	TEXT	String format: <"pan"> <"tilt"> <"zoom"> pan: <-30..30> tilt: <-18..18> zoom: <100..400>	0 0 100	Default PTZ settings for home position. When the device detects that the upstream USB connection has been established, either at startup or after a USB disconnection, it will revert to the default PTZ settings.
camera.camera-flicker	NUMBER	1 : 50Hz 2 : 60Hz	2	Camera's flicker setting. Adjust this setting to the frequency on the power main lines in the building.
camera.camera-image-defaults	TEXT	String format: <"backlight"> <"brightness"> <"contrast"> <"saturation"> <"sharpness"> <"hue"> <"gamma"> backlight: <0..5> brightness: <0..250> contrast: <60..140> saturation: <50..150> sharpness: <0..255> hue: <0..180> gamma: <1..255>	0 125 110 100 50 90 255	Configure the camera image default settings. These are Backlight, Brightness, Contrast, Saturation, Sharpness, Hue, and Gamma in this order. Default Values are: 0 ... backlight 125 ... brightness 110 ... contrast 100 ... saturation 50 ... sharpness 90 ... hue 255 ... gamma

Property	Type	Values	Default Value	Description
bt.bt-enable	BOOLEAN	0 : disable 1 : enable	1	Enable or disable Bluetooth basic-rate.
bt.bt-name	TEXT	Name of device. Default value is the product name concatenated with the system's BT MAC address	"Yamaha CS-700 " + BT MAC address	The Bluetooth basic-rate device name advertised over the air.
bt.bt-pin	TEXT	pin : 4-digit string	0000	The Bluetooth basic-rate pin for pairing. Pins are 4 digits.
bt.bt-pair-timeout	NUMBER	0 : No timeout 30, 60, 90, 120 : Pairing timeout in seconds The value can only be set in increments of 30	60	Bluetooth basic-rate pairing timeout in seconds. After this time, the pairing mode will stop. A value of 0 indicates no timeout.
bt.enable-nfc	BOOLEAN	0 : Disable NFC and NFC LED 1 : Enable NFC and NFC LED	1	Enable/disable NFC and the NFC logo LED on the main unit.
bt.bt-call-autojoin	BOOLEAN	0 : Disable 1 : Enable	0	Enable/disable Bluetooth call auto-join
bt.bt-auto-unpair	BOOLEAN	0 : Disable 1 : Enable	0	Enable/disable Bluetooth device auto-unpair
net.dhcp	BOOLEAN	0 : Disable DHCP 1 : Enable DHCP	1	Enables or disables DHCP. If DHCP is disabled, the Static IP Address, Subnet Mask, and Default Gateway must be specified.
net.ip	TEXT	IP address		IP Address assigned to the device.
net.subnet	TEXT	IP address		Subnet Mask to determine the subnet to which the device belongs.
net.gateway	TEXT	IP address.		The Default Gateway is the device's default router on the IP network.
net.dns1	TEXT	IP address.		Address of the primary Domain Name System (DNS) server.
net.dns2	TEXT	IP address.		Address of the secondary Domain Name System (DNS) server.
net.vlan	INDEXED_OPTION	0 : Manually specify VLAN ID 1 : Disable VLAN 2 : Automatically detect VLAN ID	2	Specifies VLAN behavior and support for the device. 'Automatic' (2) should be used in environments that provide a Voice VLAN with automatic detection, in which case the device will determine the VLAN identifier and register in that network. If the environment uses Voice VLAN but the Voice VLAN ID cannot be detected, choose 'Enabled' (0) and specify the ID in the VLAN ID field, net.vlan-id. 'Disabled' (1) switches off VLAN capabilities.
net.vlan-id	NUMBER	1..4094 : VLAN ID	3	The manually specified LAN ID, from 1..4094. If the VLAN mode is automatic, this is the detected VLAN ID if VLAN is active.

Property	Type	Values	Default Value	Description
net.ntp1	TEXT	IP address or URL or DNS name.	0.pool.ntp.org	Configure first NTP (Network Time Protocol) server address.
net.ntp2	TEXT	IP address or URL or DNS name.	1.pool.ntp.org	Configure second NTP (Network Time Protocol) server address.
net.ntp3	TEXT	IP address or URL or DNS name.	2.pool.ntp.org	Configure third NTP (Network Time Protocol) server address.
net.ntp4	TEXT	IP address or URL or DNS name.		Configure fourth NTP (Network Time Protocol) server address.
net.dot1x-enabled	BOOLEAN	0 : Disable 802.1x authentication 1 : Enable 802.1x authentication	0	Enables 802.1x authentication to access the network. When enabled, the required MD5 credentials – identity and password - also need to be specified.
net.dot1x-identity	TEXT	username : String.		Set a 802.1x authentication identity.
net.dot1x-password	TEXT	password : String.		Set a 802.1x authentication password.
voip.registrar	TEXT	IP address or DNS name.		The IP address or DNS name of the SIP registrar server. Required for VoIP call support.
voip.registrar-backup	TEXT	IP address or DNS name.		The IP address or DNS name of a failover SIP registrar.
voip.realm	TEXT	Realm string.	*	Realm of the credential to authenticate against the VoIP server. The value here must match the realm sent by the server in the WWW-Authenticate or Proxy-Authenticate header in the 401/407 response. An asterisk (*) causes the endpoint to respond to any realms.
voip.proxy	TEXT	IP address or name. Separate multiple addresses by a comma. Add ";lr" suffix for loose routing.		The outbound SIP proxy server's IP address or name. If there are multiple SIP proxies, separate the addresses by a comma. Also note that if the allow strict routing option is set and you have a SIP proxy that is configured for loose routing, add the designation after the proxy's address, for example, '10.10.10.10;lr'.
voip.reg-use-proxy	INDEXED_OPTION	0 : No proxy 1 : Outbound only 2 : Acc only 3 : All	0	Indicates whether the SIP proxy server(s) specified in "proxy" property should be used when registering. Selecting this option will add the listed proxy server(s) to the route headers of the SIP REGISTER request.
voip.user	TEXT	SIP username.		SIP username for the account used to authenticate with the SIP registrar and proxies.
voip.password	TEXT	SIP user password.		SIP password for the account used to authenticate with the SIP registrar and proxies.
voip.id	TEXT	SIP ID.		SIP ID used for SIP registration. If this field is left blank, the voip.user (User name) field will be used as the ID.



Property	Type	Values	Default Value	Description
voip.name	TEXT	VoIP Display Name.		VoIP Display Name. The Display Name is shown when an outbound call is made. If no Display Name is provided, the User name will be used. Please note that the IP PBX might override the Display name sent by the device and replace it with names configured in the Call Manager.
voip.reg-timeout	NUMBER	1..604800 : Registration timeout in seconds	60	Registration Timeout is the optional timeout for SIP account registration, in seconds. The maximum is 604800, which is 7 days.
voip.rereg-delay	NUMBER	1..604800 : Auto re-registration retry interval in seconds	300	Configure auto re-registration retry interval in seconds. If SIP registration is unsuccessful, this property specified the time duration between retry attempts in seconds.
voip.use-timer	INDEXED_OPTION	0 : Inactive 1 : Optional 2 : Mandatory 3 : Always	1	Specify the preference for using SIP session keep-alive timers.
voip.timer-se	NUMBER	90..604800 : Session timer in seconds	1800 (30 minutes)	The expiration period (seconds) is the interval at which the phone will consider the SIP session timed out if it does not receive a refresh message from the remote phone. It is measured in seconds and must be greater than 90.
voip.timer-min-se	NUMBER	1..604800 : Minimum session timer value in seconds	90	SIP session timer minimal expiration period (seconds). This is the minimum period that the device will accept when negotiating the expiration period with the remote phone. If the session timer expiration duration is less than this value, this value is used instead. It is measured in seconds.
voip.use-100rel	BOOLEAN	0 : Disable reliable provisional responses 1 : Enable reliable provisional responses	0	Implements reliable SIP provisional responses. SIP is a request-response type of protocol with two types of responses: provisional and final. Final responses are sent reliably, using an ACK to ensure receipt. Provisional responses by default are not sent reliably and do not require an ACK; however, in some cases, such as for PSTN interoperability support, reliability of provisional types of responses is needed. Choose this option to add the PRACK (provisional ACK) message support for reliability.

Property	Type	Values	Default Value	Description
voip.auto-update-nat	BOOLEAN	0 : Disable NAT 1 : Enable NAT	1	Configure whether SIP traversal behind NAT is disabled. Used for device behind a symmetric NAT (Network Address Translation). When enabled, the device will keep track of the public IP address from the response of the REGISTER request. If it detects that the address has changed, it will unregister the current Contact, update the Contact with the transport address obtained from the Via header, and register a new Contact to the SIP registrar. This option will also update the public name of the UDP transport if STUN is configured.
voip.dtmf-method	TEXT	0 : RTP -- RFC2833 1 : SIP INFO 2 : In-band	0	DTMF signaling method.
voip.dtmf-rtp-payload-type	TEXT	96..127	96	Specify the dynamic RTP payload type for DTMF transport using RTP.
voip.media-onhold-method	BOOLEAN	0 : M line only -- RFC3264 1 : M and C line -- RFC2543	0	The Media on Hold method setting allows switching the Media on Hold behavior between the different RFC definitions. 'M line only (RFC3264)' (0) implements the functionality according to RFC3264. In the INVITE message SDP body, the attribute 'a=sendonly' is set to a designated media stream to put media on-hold. 'M and C line (RFC2543)' (1) implements the functionality according to RFC2543. In the INVITE message SDP body, the connection line ip is set to '0.0.0.0' (e.g. 'c= IN IP4 0.0.0.0'), and the attribute 'a=inactive' is added.
voip.use-srtp	INDEXED_OPTION	0 : Disabled -- Do not use SRTP; always use RTP 1 : Optional -- Use the optional disposition for SRTP in SDP; if the remote end supports SRTP then use SRTP; otherwise use RTP 2 : Mandatory -- Force use of SRTP; if the remote end does not support SRTP the call does not connect	0	Controls Secure Real-time Transport Protocol (SRTP) usage.

Property	Type	Values	Default Value	Description
voip.rtp-port	NUMBER	1024..65535 : Port number	4000	Base port number for VoIP RTP. RTP is originated and received on even port numbers, and the associated RTCP uses the next higher odd port number.
voip.set-qos	BOOLEAN	0 : Disable QoS 1 : Enable QoS	0	Option to enable QoS (Quality of Service) tagging for SIP and media. For layer 3, at the Internet layer, the DiffServ (Differentiated Services) precedence level is Class 3. The Differentiated Services Code Point (DSCP) in the IP header is set to 24 (0x18). For layer 2, IEEE 802.1p tagging is supported.
voip.udp-tcp-selection	BOOLEAN	0 : UDP 1 : TCP	0	Transport that will be used for SIP messages.
voip.local-port	NUMBER	1024..65535 : Port number	5060	Specifies the local port for SIP transport.
voip.ip-addr	TEXT	ip-address : IP address		Configure optional address to advertise as the address of this transport. Can specify any address or hostname for this field. For example, it can point to the public address of a NAT router where port mappings have been configured for SIP.
voip.bound-addr	TEXT	ip-address : IP address		Configure bound IP address we intend to use.
voip.no-refer-sub	BOOLEAN	0 : Disable suppressing subscription 1 : Enable suppressing subscription	0	Enable or disable suppress subscription during transfer. When transferring a SIP call, the SIP REFER process automatically establishes a temporary event subscription to notify the party initiating the transfer about the receiver's status in handling the REFER. In some cases these event subscriptions and notifications are not needed, such as when forking is not used. Enable this option to suppress the automatic event subscriptions when transferring calls. (See IETF RFC 4488.)
voip.min-size	BOOLEAN	0 : Do not use compact format 1 : Use compact format.	0	Use compact SIP message format. The SIP protocol specifies that header field names can be in the full name form or in the abbreviated form. Abbreviated form is useful when messages might be too large to be carried on the available transport, for example when exceeding UDP's Maximum Transmission Unit (MTU). Enable this option to encode SIP headers in their short forms to reduce size. By default, the option is not enabled and SIP headers in outgoing messages will be encoded in their full names. (See SIP protocol standard, IETF RFC 3261.)

Property	Type	Values	Default Value	Description
voip.allow-strict	BOOLEAN	0 : Enable strict routing 1 : Disable strict routing	0	Allow strict routing for SIP registration proxies. By default, proxies specified for SIP registration will be configured as loose-routing proxies. The loose-routing designation will be automatically appended to each proxy address when the proxy is added to the SIP Route header. Older proxies may be strict-routing (see IETF RFC 2543), not supporting loose routing (see IETF RFC 3261). Enable this option if you are using strict-routing proxies. If this option is enabled and you are specifying one or more loose-routing proxies in the Proxy field, then you must manually add the suffix to each loose-routing proxy address. For example, "10.134.123.101;lr".
voip.stun-srv	TEXT	stun-address : String. IP address, domain name, or host name, and optional port number. Separate multiple addresses by comma.		Specifies the STUN (Session Traversal Utilities for NAT) server IP address or name to use to determine if the phone is behind a NAT, the type of NAT, and the public address of the phone. The field can contain a comma separated list of servers. Each server can be a domain name, host name, or IP address, and it may contain an optional port number. (For STUN see IETF RFC 5389.)
voip.use-ice	BOOLEAN	0 : Disable ICE 1 : Enable ICE	0	Enables the use of the ICE (Interactive Connectivity Establishment) protocol for NAT traversal. ICE takes advantage of STUN and TURN to identify candidates (IP addresses and ports) for communication, evaluating and prioritizing the candidate pairs to select the best route. Expensive candidates, such as using a media relay, are selected only as a last resort. (For ICE see IETF RFC 5245.)

Property	Type	Values	Default Value	Description
voip.ice-regular	BOOLEAN	0 : Regular nomination method 1 : Aggressive nomination method	1	ICE nomination method. When using ICE, select the preferred ICE Nomination Method. To validate candidate pairs (IP addresses and ports for the local and remote nodes), CS-700 sends STUN binding requests as part of the media connectivity tests. When a candidate is nominated for use, a STUN binding request is sent with a flag indicating that the candidate pair is nominated. There are two nomination methods that can be used: Regular -For Regular Nomination, CS-700 validates candidate pairs with initial STUN binding requests, and then selects a valid candidate pair by sending another STUN binding request with a flag indicating that the pair is nominated. Aggressive -For Aggressive Nomination, CS-700 does not wait to set the nominated flag in a second STUN binding request, but rather sets the flag in the STUN binding requests for all of the candidate pairs. The ICE processing completes when the first pair successfully passes connectivity checks. The aggressive method is faster but does not always result in the optimal path being selected.
voip.ice-max-hosts	NUMBER	0 : No maximum 1..10 : Maximum number of host candidates	5	Maximum number of ICE host candidate. An ICE host candidate is an actual local transport address in the host. Host transport addresses are obtained by binding to attached network interfaces. These interfaces include both physical interfaces and virtual interfaces such as VPN. This option specifies the maximum number of local ICE host candidates that may be used in evaluating candidate pairs when determining the best route. A value of 0 indicates that there is no maximum.
voip.ice-no-rtcp	BOOLEAN	0 : Enable RTCP 1 : Disable RTCP	0	Option to not disable the RTCP component in ICE.
voip.use-turn	BOOLEAN	0 : Disable TURN 1 : Enable TURN	0	Enables the use of a TURN (Traversal Using Relay NAT) relay when using ICE. A TURN relay is a media relay server residing on the public internet which can relay media data packet between clients. TURN relays are used when other preferred mechanisms are not available, such as STUN or direct connectivity. If TURN is enabled, the other TURN settings (server, username and password) must also be specified.

Property	Type	Values	Default Value	Description
voip.turn-srv	TEXT	address : String. The format is either 'DOMAIN:PORT' or 'HOST:PORT'.		TURN server domain name or hostname, and port.
voip.turn-user	TEXT	User name.		Username to authenticate against the TURN server.
voip.turn-passwd	TEXT	Password.		Password to authenticate against the TURN server.
voip.turn-tcp	BOOLEAN	0 : Do not use TCP; use UDP 1 : Use TCP	0	Configure whether to use TCP on TURN relay; otherwise use UDP.
voip.codec1	INDEXED_OPTION	1 : G.722 2 : G.711 u-law (PCMU) 3 : G.711 A-law (PCMA) 4 : G.726 5 : G.729	1	Highest prioritized codec. This codec cannot be set to "None", select a codec in the value 1 to 5.
voip.codec2	INDEXED_OPTION	0 : None 1 : G.722 2 : G.711 u-law (PCMU) 3 : G.711 A-law (PCMA) 4 : G.726 5 : G.729	2	Second highest prioritized codec. Select a codec in the value 0 to 5.
voip.codec3	INDEXED_OPTION	0 : None 1 : G.722 2 : G.711 u-law (PCMU) 3 : G.711 A-law (PCMA ) 4 : G.726 5 : G.729	3	Third highest prioritized codec. Select a codec in the value 0 to 5.
voip.codec4	INDEXED_OPTION	0 : None 1 : G.722 2 : G.711 u-law (PCMU) 3 : G.711 A-law (PCMA) 4 : G.726 5 : G.729	4	Fourth highest prioritized codec. Select a codec in the value 0 to 5.
voip.codec5	INDEXED_OPTION	0 : None 1 : G.722 2 : G.711 u-law (PCMU) 3 : G.711 A-law (PCMA)	5	Lowest prioritized codec. Select a codec in the value 0 to 5.

Property	Type	Values	Default Value	Description
		4 : G.726 5 : G.729		
voip.ptime	NUMBER	10..60 : ptime interval in ms	20	The ptime (packetization interval) value for a codec determines the length of time in milliseconds represented by the media in an RTP packet which is used to transmit audio traffic. The valid range is 10 to 60 in 10 ms increments.
voip.mwi	BOOLEAN	0 : Disable MWI signaling 1 : Enable MWI signaling	0	Enable displaying the message waiting indicator (MWI) on the device and enable receiving message waiting notifications from the PBX. The PBX must be configured to support voice mail for the registered user in order for this feature to work properly.
voip.vm-number	TEXT	VoIP voicemail number.		The number that is dialed when voicemail is called from the UI.
voip.do-not-disturb	BOOLEAN	0 : Disable DND 1 : Enable DND	0	Configure do-not-disturb (DND) setting.
voip.auto-answer	NUMBER	0 : Disable auto-answer 200 : Enable auto-answer	0	Auto answer incoming VoIP calls. We recommend enabling this feature only for test purposes. If the phone is set to Do Not Disturb or if there are no available lines, the Forward rules will apply. If there are no Forward rules specified, the incoming call will be sent to voice mail. If voice mail is not supported, the call will be rejected.
voip.duration	NUMBER	0 : No maximum 1..10080 : Maximum VoIP call duration in minutes	0	Specifies the maximum VoIP call duration in minutes. When the call duration reaches the maximum duration, the call will be automatically terminated. The maximum limit is 10,080 minutes, or 7 days. A 0 indicates no maximum call duration.
voip.dial-plan	TEXT	dialplan : Dial plan string.		Specifies the VoIP dial plan string. See the Appendix for a detailed description of dial plan settings.
voip.always-forwarding	BOOLEAN	0 : Disable 1 : Enable	0	Enable or disable forwarding all incoming VoIP calls to the specified number.
voip.always-forwarding-num	TEXT	VoIP dialing number.		Forward all incoming VoIP calls to the specified number.
voip.busy-forwarding	BOOLEAN	0 : Disable 1 : Enable	0	Enable or disable forwarding incoming calls to the specified number if the local phone is in 'Do Not Disturb' mode or if both lines are busy.

Property	Type	Values	Default Value	Description
voip.busy-forwarding-num	TEXT	VoIP dialing number.		Forward incoming calls to the specified number if the local phone is in 'Do Not Disturb' mode or if both lines are busy.
voip.noanswer-forwarding	BOOLEAN	0 : Disable 1 : Enable	0	Enable or disable forwarding incoming VoIP calls to the specified number if the call is not answered within the duration specified in the 'noanswer-delay' attribute.
voip.noanswer-forwarding-num	TEXT	VoIP dialing number.		Forward incoming VoIP calls to the specified number if the call is not answered within the duration specified in the 'noanswer-delay' attribute.
voip.noanswer-delay	NUMBER	2..30 : Seconds to wait before forwarding a call	10	Number of seconds to wait before forwarding an unanswered incoming call to the 'noanswer-forwarding-num' number.

Firmware attributes	Type	Values	Default Value	Description
version	TEXT	""		Provide the firmware version.



## Using the Application Programming Interface (API)

The Yamaha CS-700 provides an interface to integrate into third party applications to control and manage the unit directly without the use of Yamaha's management interfaces. The API allows accessing the CS-700 unit either over an USB connection or the network. Use cases are for example integrations with room control systems.

The API and full documentation of the interface can be downloaded from <https://uc.yamaha.com/products/video-sound-bar/huddle-room-system/>. The API is available in the form of C-libraries for Windows and macOS operating systems.

Please see the following sections for the description of a subset of the available functions and commands.

### USB API functions

#### *CsDevComm\_Mode* enum

Description: Enumeration of USB connections type. The client should specify the connection type, Auto, Hid, or Bulk, at the start of a session. Auto will select Bulk if available otherwise Hid. Bulk is preferable when upgrading firmware.

Syntax:

```
typedef enum {
    CsDevComm_Mode_Auto = 0,
    CsDevComm_Mode_Hid,
    CsDevComm_Mode_Bulk,
    CsDevComm_Mode_Num
} CsDevComm_Mode;
```

#### *devAttach*

Description: Establish USB communication with a device.

Syntax:

```
EXPORT int __cdecl devAttach(int mode, void(*debug_callback)(char *msg),
                             void(*event_callback)(int type));
```

Parameters:

Parameter	Description
<code>mode</code>	The USB connection mode, either Auto, HID or Bulk, chosen from enum <code>CsDevComm_Mode</code> .
<code>debug_callback</code>	Pointer to callback function to handle debug messages.
<code>msg</code>	Pointer to debug message.

<b>event_callback</b>	Pointer to callback function to handle events.
<b>type</b>	Type of event as listed in table below.

Return Values:

Value	Description
-1	General error
0	Success
1	No device connected
2	Failed authentication

Event Types:

Type	Description
<b>0xFF</b>	Device disconnected

### ***devDetach***

Description: Disconnect session.

Syntax:

```
EXPORT void __cdecl devDetach(void);
```

Return Values:

Value	Description
-1	General error
0	Success

### ***isConnected***

Description: Get the USB connection status.

Syntax:

```
EXPORT int __cdecl isConnected(void);
```

Return Values:

Value	Description
-1	General error
0	Not connected
1	Connected HID
2	Connected Bulk

## ***coreCliCmd***

Description: Send a CLI-format command to the device. Commands are listed in the section “USB/Telnet CLI Commands”.

Syntax:

```
EXPORT int __cdecl coreCliCmd(char *cmd, char* rsp, int len);
```

Parameters:

Parameter	Description
cmd	CLI command string (see API Command Reference)
rsp	Pointer to response string
len	Bytes available in response string

Return Values:

Value	Description
-1	General failure
0	Success

## ***notifCtrl***

Description: Enable/disable notifications and register a callback function to handle CLI-format notifications. The notifications are defined in the next section. Notifications are automatically disabled if the device is disconnected.

Syntax:

```
EXPORT int __cdecl notifCliCtrl(int mode, void(*notif_callback_t)(char *msg));
```

Parameters:

Parameter	Description
mode	Enable/disable notifications
notif_callback_t	Pointer to callback function to handle CLI notification
msg	Callback function parameter: Notification message string

Return Values:

Value	Description
-1	General failure
0	Success

## Telnet / SSH interface

To use a Telnet or SSH IP connection for the control, with the CS-700 being the server, the “Enable room control access” on the Admin Settings page of the web UI has to enable either Telnet or SSH.

The screenshot shows the 'SECURITY SETTINGS' page of the 'CS-700 Device Manager' web interface. The page has a purple header with the Yamaha logo and 'CS-700 Device Manager' text, and a 'LOGOUT' button with an external link icon. A 'SUBMIT' button is located in the top right corner. The settings are as follows:

- Enable call history *i*
- Require HTTPS *i*
- Enable room control access: Room control enabled using Telnet *i*
- Room control password:  *i*

Start the Telnet/SSH connection by connecting to the IP address of the CS-700 unit. CS-700 provides the standard Telnet port number 23 or the standard SSH port number 22. The username is **roomcontrol** and the password is **Yamaha-CS-700**, both case sensitive. Once connected, CLI commands as listed in the next section can be sent to the CS-700.

## USB/Telnet/SSH CLI Commands

Below a subset of the available commands is listed including the properties, status items and parameters that are available. Notifications are identified with their corresponding property or status item. Examples for using these commands with the CLI are provided.

The command syntax is as follows:

<parameter>	Items in angle brackets are parameters
<"call-status">	A quoted item represents the name of a parameter further described in the Parameters section.
<0 1 2>	A list of possible values are separated by vertical bars.
<connected disconnected>	An unquoted parameter is a literal value.
<0..10>	A range of values is separated by an ellipsis.
<"paired"> [<"mac"> <"name">]	Square brackets designate optional parameters.
[<"mac"> <"name">]+	A list of repeating values is designated by a plus sign.

For properties, the description lists the actions that can be performed on the property, including:

- get – property can be read; this is true of all properties
- set – property can be set
- notify – when the property changes, a notification is sent to registered clients

### ***usb-conn-status***

Description: Query USB connection status.

Property Actions: get, notify

Command Definition:

Action	Definition
get	get usb-conn-status
response	val usb-conn-status <0 1>
notify	notify sys.usb-conn-status <0 1>

Parameters:

Parameter	Description
0	USB is disconnected.
1	USB is connected.

Format Examples:

```
get usb-conn-status  
val usb-conn-status 1
```

```
notify sys.usb-conn-status 1
```

Supported Products: CS700-AV, CS700-SP

### ***speaker-volume***

Description: Configure speaker volume for calls. 1 .. 18.

Property Actions: set, get, notify

Default Value: 13

Command Definition:

Action	Definition
get	get speaker-volume

response	val speaker-volume <1..18>
set	set speaker-volume <1..18>
notify	notify audio.speaker-volume <1..18>

Parameters:

Parameter	Description
1 .. 18	Volume setting

Format Examples:

```
get speaker-volume
val speaker-volume 13
```

```
set speaker-volume 13
```

```
notify audio.speaker-volume 13
```

Supported Products: CS700-AV, CS700-SP

### ***ringer-volume***

Description: Configure VoIP ringer volume. 1 .. 18.

Property Actions: set, get, notify

Default Value: 13

Command Definition:

Action	Definition
get	get ringer-volume
response	val ringer-volume <1..18>
set	set ringer-volume <1..18>
notify	notify audio.ringer-volume <1..18>

Parameters:

Parameter	Description
1 .. 18	Ringer volume level

Format Examples:

```
get ringer-volume
val ringer-volume 13
```

```
set ringer-volume 13
```

```
notify audio.ringer-volume 13
```

Supported Products: CS700-SP

### ***speaker-mute***

Description: Mute speaker.

Property Actions: set, get, notify

Command Definition:

Action	Definition
<b>get</b>	get speaker-mute
<b>response</b>	val speaker-mute <0 1>
<b>set</b>	set speaker-mute <0 1>
<b>notify</b>	notify audio.speaker-mute <0 1>

Parameters:

Parameter	Description
<b>0</b>	Speaker is not muted
<b>1</b>	Speaker is muted

CLI Format Examples:

```
get speaker-mute
val speaker-mute 1
```

```
set speaker-mute 0
```

```
notify audio.speaker-mute 1
```

Supported Products: CS700-AV, CS700-SP, CS700-DL, CS700-DS

## ***mute***

Description: Mute microphones.

Property Actions: set, get, notify

Command Definition:

Action	Definition
<b>get</b>	get mute
<b>response</b>	val mute <0 1>
<b>set</b>	set mute <0 1>
<b>notify</b>	notify audio.mute <0 1>

Parameters:

Parameter	Description
<b>0</b>	Unmute mics
<b>1</b>	Mute mics

Format Examples:

```
get mute
val mute 0
```

```
set mute 0
```

```
notify audio.mute 0
```

Supported Products: CS700-AV, CS700-SP, CS700-DL, CS700-DS

### ***camera-ptz-home***

**Description:** PTZ settings for the default home position. When the CS-700 detects that an USB connection has been established to a computer, either at startup or after a previous USB disconnection, it will revert to the PTZ home settings. Calling set on this property will move the camera to the newly defined PTZ position.

**Property Actions:** set, get, notify

**Default Value:** 0 0 100

**Command Definition:**

Action	Definition
<b>get</b>	get camera-ptz-home
<b>response</b>	val camera-ptz-home <"pan"> <"tilt"> <"zoom">
<b>set</b>	set camera-ptz-home <"pan"> <"tilt"> <"zoom">
<b>notify</b>	notify camera.camera-ptz-home <"pan"> <"tilt"> <"zoom">

**Parameters:**

Parameter	Description
-30..30	Pan setting (default value is 0)
-18..18	Tilt setting (default value is 0)
100..400	Zoom setting (default value is 100)

**CLI Format Examples:**

```
get camera-ptz-home  
val camera-ptz-home 0 0 100
```

```
set camera-ptz-home 0 0 100
```

```
notify camera.camera-ptz-home 0 0 100
```

Supported Products: CS700-AV, CS700-SP, CS700-DL, CS700-DS

### ***camera-image-defaults***

**Description:** Camera image default settings. The settings impacted by this property are Backlight, Brightness, Contrast, Saturation, Sharpness, Hue, and Gamma. The order of the parameters is relevant. None of the parameter can be left out. The Camera image defaults are not automatically applied when setting these values. To apply the values call the cam-image-apply-defaults property.

**Property Actions:** set, get, notify

**Default Values:** 0 125 110 100 50 90 255



Command Definition:

Action	Definition
get	get camera-image-defaults
response	val camera-image-defaults <"backlight"> <"brightness"> <"contrast"> <"saturation"> <"sharpness"> <"hue"> <"gamma">
set	set camera-image-defaults <"backlight"> <"brightness"> <"contrast"> <"saturation"> <"sharpness"> <"hue"> <"gamma">
notify	notify camera.camera-image-defaults <"backlight"> <"brightness"> <"contrast"> <"saturation"> <"sharpness"> <"hue"> <"gamma">

Parameters:

Parameter	Description
0..5	Backlight setting
0..250	Brightness setting
60..140	Contrast setting
50..150	Saturation setting
0..255	Sharpness setting
0..180	Hue setting
1..255	Gamma setting

CLI Format Examples:

```
get camera-image-defaults  
val camera-image-defaults 0 125 110 100 50 90 255
```

```
set camera-image-defaults 0 125 110 100 50 90 255
```

```
notify camera.camera-image-defaults 0 125 110 100 50 90 255
```

Supported Products: CS700-AV, CS700-SP, CS700-DL, CS700-DS

## ***camera-backlight***

Description: Backlight compensation for camera.

Property Actions: set, get, notify

Default Value: 0

Command Definition:

Action	Definition
get	get camera-backlight
response	val camera-backlight <0..5>
set	set camera-backlight <0..5>
notify	notify camera.camera-backlight <0..5>

Parameters:

Parameter	Description
0	Off
1..5	Camera backlight level.

CLI Format Examples:

```
get camera-backlight
val camera-backlight 0
```

```
set camera-backlight 0
```

```
notify camera.camera-backlight 0
```

Supported Products: CS700-AV, CS700-SP

### ***camera-mute***

Description: Camera video "mute" or stop state.

Property Actions: set, get, notify

Command Definition:

Action	Definition
get	get camera-mute
response	val camera-mute <0 1>
set	set camera-mute <0 1>
notify	notify camera.camera-mute <0 1>

Parameters:

Parameter	Description
0	Camera video is unmuted
1	Camera video is muted

Format Examples:

```
get camera-mute
val camera-mute 0
```

```
set camera-mute 0
```

```
notify camera.camera-mute 0
```

Supported Products: CS700-AV, CS700-SP

### ***camera-pan***

Description: Camera's digital pan setting. Camera can only be panned when zoomed in.

Property Actions: set, get, notify

Default Value: 0

Command Definition:

Action	Definition
get	get camera-pan
response	val camera-pan <-30..30>
set	set camera-pan <-30..30>
notify	notify camera.camera-pan <-30..30>

Parameters:

Parameter	Description
-30 .. 30	Pan setting

Format Examples:

```
get camera-pan
val camera-pan 0
```

```
set camera-pan 0
```

```
notify camera.camera-pan 0
```

Supported Products: CS700-AV, CS700-SP, CS700-DL, CS700-DS

### ***cam-pan-left***

Description: Decrease the camera pan value by one – move the image one step to the left.

Command Definition:

Action	Definition
Execute	cam-pan-left
Notify	notify camera.pan <-30..30>

Parameters: None

CLI Format Examples:

```
cam-pan-left
notify camera.pan 10
```

Supported Products: CS700-AV, CS700-SP

### ***cam-pan-right***

Description: Increase the camera pan value by one – move the image one step to the right.

Command Definition:

Action	Definition
Execute	cam-pan-right
Notify	notify camera.pan <-30..30>

Parameters: None

CLI Format Examples:

```
cam-pan-right  
notify camera.pan 8
```

Supported Products: CS700-AV, CS700-SP, CS700-DL, CS700-DS

### ***camera-tilt***

Description: Camera's digital tilt setting. Camera can only be tilted when zoomed in.

Property Actions: set, get, notify

Default Value: 0

Command Definition:

Action	Definition
get	get camera-tilt
response	val camera-tilt <-18..18>
set	set camera-tilt <-18..18>
notify	notify camera.camera-tilt <-18..18>

Parameters:

Parameter	Description
-18.. 18	Tilt setting Default value is 0

Format Examples:

```
get camera-tilt  
val camera-tilt 0
```

```
set camera-tilt 0
```

```
notify camera.camera-tilt 0
```

Supported Products: CS700-AV, CS700-SP, CS700-DL, CS700-DS

### ***cam-tilt-up***

Description: Increase the current camera tilt by one.

Command Definition:

Action	Definition
Execute	cam-tilt-up
Notify	notify camera.tilt <-18..18>

Parameters: None

CLI Format Examples:

```
cam-tilt-up
notify camera.tilt 8
```

Supported Products: CS700-AV, CS700-SP

### ***cam-tilt-down***

Description: Decrease the current camera tilt by one.

Command Definition:

Action	Definition
Execute	cam-tilt-down
Notify	notify camera.tilt <-18..18>

Parameters: None

CLI Format Examples:

```
cam-tilt-down
notify camera.tilt 5
```

Supported Products: CS700-AV, CS700-SP, CS700-DL, CS700-DS

### ***camera-zoom***

Description: Camera's digital zoom setting. When zoom is set to 100, the pan and tilt settings will be forced to their default value.

Property Actions: set, get, notify

Default Value: 100

Command Definition:

Action	Definition
get	get camera-zoom
response	val camera-zoom <100..400>
set	set camera-zoom <100..400>
notify	notify camera.camera-zoom <100..400>

Parameters:

Parameter	Description
100 .. 400	Zoom setting

Format Examples:

```
get camera-zoom
val camera-zoom 100
```

```
set camera-zoom 100
```

```
notify camera.camera-zoom 100
```

Supported Products: CS700-AV, CS700-SP, CS700-DL, CS700-DS

### ***cam-zoom-in***

Description: Zoom in by one level.

Command Definition:

Action	Definition
Execute	cam-zoom-in
Notify	notify camera.zoom <100..400>

Parameters: None

CLI Format Examples:

```
cam-zoom-in  
notify camera.zoom 200
```

Supported Products: CS700-AV, CS700-SP

### ***cam-zoom-out***

Description: Zoom out by one level.

Command Definition:

Action	Definition
Execute	cam-zoom-out
Notify	notify camera.zoom <100..400>

Parameters: None

CLI Format Examples:

```
cam-zoom-out  
notify camera.zoom 100
```

Supported Products: CS700-AV, CS700-SP

### ***cam-apply-defaults***

Description: Apply the camera's default PTZ settings. These settings are also automatically applied when the device detects that the upstream USB connection has been established, either at startup or after a USB disconnection.

Command Definition:

Action	Definition
execute	cam-apply-defaults

Parameters: None

Format Examples:

```
cam-apply-defaults
```

Supported Products: CS700-AV, CS700-SP

### ***cam-image-apply-defaults***

Description: Apply the camera's default Backlight, Brightness, Contrast, Saturation, Sharpness, Hue, and Gamma settings. These settings are also automatically applied when the device detects that the upstream USB connection has been established, either at startup or after a USB disconnection.

Command Definition:

Action	Definition
execute	cam-image-apply-defaults

Parameters: None

CLI Format Examples:

```
cam-image-apply-defaults
```

Supported Products: CS700-AV, CS700-SP

### ***status***

Description: Query a call status.

Property Actions: get, notify

Command Definition:

Action	Definition
get	get status <1..3 usb bt>
response	val status <1..3 usb bt> <"call-status">
notify	notify call.status <1..3 usb bt> <"call-status">

Parameters:

Parameter	Description
1	VoIP line 1
2	VoIP line 2
3	VoIP line 3 (used for transfer)
usb	USB line
bt	Bluetooth line

call-status	String as shown below for each call type.
<b>VoIP Calls</b>	
idle	Initialization state.
incoming	Receiving incoming VoIP call.
calling	Initiating outgoing VoIP call.
failed	Outgoing call attempt failed; it is followed by "disconnected" when the attempt is disconnected.
connected	Call is connected.
onhold	Call is on hold.
connected-in-conf	Call is in a conference.
disconnected	Not in a call or phone is not registered.
update	The call is transferred by the far end (with some call managers the call state will remain "connected" after the transfer).
missed	Incoming VoIP call missed due to Do-Not-Disturb.
<b>USB Calls</b>	
active	USB audio is active.
idle	Initialization state.
incoming	Incoming USB call signal is received from host.
inactive	USB audio is not active.
onhold	USB audio is on hold.
connected-in-conf	Call is in a conference.
<b>BT Calls</b>	
active	BT audio is active.
Idle	Initialization state.
incoming	Incoming BT call signal is received from connected phone.
inactive	BT audio is not active.
onhold	BT audio is on hold.
connected-in-conf	Call is in a conference.

**Format Examples:**

```
get status 1
val status 1 connected
```

```
notify call.status 1 connected
```

Supported Products: CS700-AV, CS700-SP

***status-all***

**Description:** Query all call status. See "call-status" property for description of status types. Status information on VoIP lines is only provided in the -SP and -DS version of the CS-700 product.

**Property Actions:** get

**Command Definition:**

Action	Definition
get	get status-all



response	val status-all line1:<"status1"> line2:<"status2"> line3:<"status3"> bt:<"statusbt"> usb:<"statususb">
----------	---

Parameters:

Parameter	Description
status1	VoIP line 1 call status
status2	VoIP line 2 call status
status3	VoIP line 3 call status
statusbt	Bluetooth call status
statususb	USB call status

Format Examples:

```
get status-all
val status-all line1:disabled line2:disabled line3:disabled bt:idle usb:idle
```

Supported Products: CS700-AV, CS700-SP, CS700-DL, CS700-DS

## ***call-info***

Description: Query call information for a given call type.

Property Actions: get

Command Definition:

Action	Definition
get	get call-info <1..3, bt, usb>
response	val call-info <1..3> <"name"> <"number"> <"call-status">

Parameters:

Parameter	Description
1	VoIP line 1
2	VoIP line 2
3	VoIP transfer line
bt	Bluetooth connection
usb	USB connection
name	String. Name of caller.
number	String. Phone number.
call-status	Call status as described in the "get status" parameter description.

CLI Format Examples:

```
get call-info 1
val call-info 1 Blake 7823 connected
```

Supported Products: CS700-AV, CS700-SP

## ***start-time***

Description: Query call start time. Return value is HH:MM:SS UTC in 24-hour time format.

Property Actions:     get

Command Definition:

Action	Definition
get	get start-time <1..3>
response	val start-time <1..3> <"time">

Parameters:

Parameter	Description
1	VoIP line 1
2	VoIP line 2
3	VoIP line 3 (used for transfer)
time	HH:MM:SS in 24-hour time format

CLI Format Examples:

```
get start-time 1
val start-time 1 13:22:41
```

Supported Products: CS700-SP

## ***dial***

Description:           Dial a VoIP call using the given number.

Command Definition:

Action	Definition
execute	dial <1..3> <"number">

Parameters:

Parameter	Description
1	VoIP line 1
2	VoIP line 2
3	VoIP line 3 (used for transfer)
number	VoIP number to dial

Format Examples:

```
dial 1 7823
```

Supported Products: CS700-SP

## ***answer***

Description:           Answer an incoming call.

Command Definition:

Action	Definition
--------	------------

execute	answer <1..2 usb bt>
---------	----------------------

Parameters:

Parameter	Description
1	VoIP line 1
2	VoIP line 2
3	VoIP line 3 (used for transfer)
usb	USB connection
bt	Bluetooth connection

Format Examples:

```
answer 1
```

Supported Products: CS700-AV, CS700-SP

## **hangup**

Description: Hang up the given call.

Command Definition:

Action	Definition
execute	hangup <1..3 usb bt>

Parameters:

Parameter	Description
1	VoIP line 1
2	VoIP line 2
3	VoIP line 3 (used for transfer)
usb	USB connection
bt	Bluetooth connection

Format Examples:

```
hangup 1
```

Supported Products: CS700-AV, CS700-SP

## **hold**

Description: Hold the given call.

Command Definition:

Action	Definition
execute	hold <1..3 usb bt all>

Parameters:

Parameter	Description
1	VoIP line 1

2	VoIP line 2
3	VoIP line 3 (used for transfer)
usb	USB call/audio
bt	BT call
all	All active calls

Format Examples:

```
hold 1
```

Supported Products: CS700-AV, CS700-SP

### **resume**

Description: Resume the given call.

Command Definition:

Action	Definition
execute	resume <1..3 usb bt>

Parameters:

Parameter	Description
1	VoIP line 1
2	VoIP line 2
3	VoIP line 3 (used for transfer)
usb	USB call/audio
bt	BT call
all	All active calls

Format Examples:

```
resume 1
```

Supported Products: CS700-AV, CS700-SP

### **swap**

Description: Swap the source call with the target call, used for swapping held calls.

Command Definition:

Action	Definition
execute	swap <"held-line-id"> <"active-line-id">

Parameters:

Parameter	Description
held-line-id <1..3 usb bt>	Line ID of call that is currently on hold; this call will be resumed
active-line-id <1..3 usb bt>	Line ID of call that is currently active; this call will be placed on hold

Format Examples:

```
swap 1 2
```

Supported Products: CS700-AV, CS700-SP

## **join**

Description: Join allows the individual lines to be mixed (joined) or not mixed (separated). Used for conferencing existing calls. Any "line-id" not specified will default to a mix state of 0.

Command Definition:

Action	Definition
execute	join <"line-id1" "mix-state"> <"line-id2" "mix_state"> [<"line-id3" "mix_state">] [<"line-id4" "mix_state">]

Parameters:

Parameter	Description
line-id1 <1..2 usb bt>	Line ID1 of call to be mixed or not mixed
line-id2 <1..2 usb bt>	Line ID2 of call to be mixed or not mixed
line-id3 <1..2 usb bt>	Line ID3 of call to be mixed or not mixed [optional]
line-id4 <1..2 usb bt>	Line ID4 of call to be mixed or not mixed [optional]
mix_state	
0	Separate lines (not mixed)
1	Join lines (mix)

CLI Format Examples:

Join (mix) only VoIP lines 1 and 2

```
join 1 1 2 1 usb 0 bt 0  
join 1 1 2 1
```

Separate (not mixed) all calls from a conference

```
join 1 0 2 0 usb 0 bt 0
```

Supported Products: CS700-SP

## **transfer**

Description: Transfer the source call to target call. The target call was previously initiated and can either be in an "establishing" state (blind transfer) or a "connected" state (acknowledged transfer). After the call has been successfully transferred, both lines are released.

Command Definition:

Action	Definition
execute	transfer <"source-line-id"> <"target-line-id">

Parameters:

Parameter	Description
source-line-id <1..2>	Line ID of call being transferred
target-line-id <3>	Line ID of call to which the source will be transferred

Format Examples:

```
hold 1
dial 3 5555555555
transfer 1 3
```

Supported Products: CS700-AV, CS700-SP

### ***vm-count***

Description: Query voice mail count via VoIP from the Call Manager.

Property Actions: get, notify

Command Definition:

Action	Definition
get	get vm-count
response	val vm-count <"vm-count">
notify	notify voip.vm-count <"vm-count">

Parameters:

Parameter	Description
vm-count	Number of VoIP voice mail messages.

CLI Format Examples:

```
get vm-count
val vm-count 2
```

```
notify voip.vm-count 2
```

Supported Products: CS700-SP

### ***do-not-disturb***

Description: Configure do-not-disturb (DND) setting.

Property Actions: set, get, notify

Default Value: 0

Command Definition:

Action	Definition
get	get do-not-disturb
response	val do-not-disturb <0 1>
set	set do-not-disturb <0 1>
notify	notify voip.do-not-disturb <0 1>

Parameters:

Parameter	Description
0	Disable DND
1	Enable DND

Format Examples:

```
get do-not-disturb
val do-not-disturb 0
```

```
set do-not-disturb 0
```

```
notify voip.do-not-disturb 0
```

Supported Products: CS700-SP

## ***dtmf***

Description: Send DTMF digit on given VoIP line during an active call. This is not to dial a number, but to send DTMF tones during the call.

Command Definition:

Action	Definition
set	set dtmf <"voip-line-id"> <"digit">

Parameters:

Parameter	Description
1	VoIP line 1
2	VoIP line 2
3	VoIP line 3 (used for transfer)
digit	dtmf digit, use "-" to stop previous digit

Format Examples:

```
set dtmf 1 5
set dtmf 1 -
```

Supported Products: CS700-SP

## ***registration***

Description: Query SIP registration status.

Property Actions: get, notify

Command Definition:

Action	Definition
<b>get</b>	get registration
<b>response</b>	val registration <"status">
<b>notify</b>	notify voip.registration <"status">

Parameters:

Parameter	Description
0	Unregistered to SIP server
999	Registration is in process
200	Registered to SIP server
403	Registration attempt failed – Forbidden
404	Registration attempt failed – Invalid User
405	Registration attempt failed – Method Not Allowed
406	Registration attempt failed – Not Acceptable

CLI Format Examples:

```
get registration  
val registration 200
```

```
notify voip.registration 200
```

Supported Products: CS700-SP



## Upgrading the Device Firmware

From time to time, new device firmware might be made available to upgrade the functionality and feature set of the CS-700 device. Download such software from <https://uc.yamaha.com/products/video-sound-bar/huddle-room-system/>. The software is packaged as a bundle file which is applied to the CS-700 directly through the Web-UI, the Service Application, or the provisioning file. The file will have a naming convention with suffix “.bundle” at the end.

### Through the Web UI

The upgrade firmware file can be used on the Tools-Update section of the web user interface to upgrade the unit. Refer to the Web UI section of this manual for more details on how perform the upgrade.

### Through the Service Application

The CS-700 firmware can be upgraded from a directly-attached PC through the Service Application. Refer to the Service Application section of this manual for more details on how perform the upgrade.

### From the Provisioning Server

To upgrade systems using the provisioning server, the firmware element in the provisioning file needs to be changed. The version attribute value needs to be changed to the correct firmware version of the file that is provided. The element value needs to be updated to the file name of the corresponding firmware bundle.

```
<firmware version="1.4.0.2">CS700-1-4-0-2.bundle</firmware>
```

Refer to the section on configuring CS-700 devices using provisioning servers and option 66 or option 150 for more details.

# **Appendix**

## **Session Control Functionality Details per Third Party Application**

### **Using Windows Computers and MacOS computers**

Audio volume and mute is integrated with the operating system. Volume changes in the operating system and the CS-700 device are communicated and reflected on both sides. Audio integration is not directly done with the applications.

### **USB 3.0 Extension Cables**

The following USB extenders have been tested for use with the CS-700 and shown good results. Please note that we cannot give guarantees that these products will work in all environments. The distance supported by each USB extender varies and is defined by the manufacturer's specifications:

- Startech Active USB 3.0 USB-A to USB-B Cable, M/M, 10M/30 Feet – SKU # USB3SAB10M.
- Cable Matters SuperSpeed USB 3.0 Type A Male to Female Active Extension Cable 5 Meters/16.4 Feet
- Newnex FireNEX-uLINK USB 3.0 16 Meters/ 50 Feet, A to B Active Repeater Extension Cable
- Newnex FireNEX-uLINK USB 3.0 20 Meters/ 65 Feet, A to B Active Repeater Extension Cable

## SNMP Support Details

The CS-700 includes an SNMP agent that can be configured to provide SNMP support.

The table below describes the SNMP configuration settings that the CS-700 administrator must configure to enable SNMP.

snmp-enable	Enable or disable SNMP support. Disabled (0) means that SNMP is not supported. Enabled (1) means that SNMP is available. Default is 0.
snmp-address	Specifies SNMP server address to which traps will be sent. Leave blank to disable traps.
snmp-community	Specifies the SNMP read-only community string used for queries from the server and transmitted traps. Read-only indicates the authorization level. The device does not support write operations initiated through SNMP. Default value is 'public'.
snmp-contact-name	Specifies the contact name, typically the system administrator. This string is informational and can include an email address. It is not associated with traps.
snmp-device-location	Specifies the location of the device for informational purposes.

The following read-only properties and traps are supported.

### Read-only Properties

- Serial number
- Base FW version
- USB connection active (0,1)
- USB microphone audio stream active (0,1)
- USB speaker audio stream active (0,1)
- USB video stream active (0,1)
- Bluetooth connection active (0,1)
- VoIP call active (0,1)

### Traps

- USB connection state changes

## SNMP MIB for the CS-700

```
CS700-MIB DEFINITIONS ::= BEGIN

    IMPORTS
        OBJECT-TYPE, NOTIFICATION-TYPE, MODULE-IDENTITY, enterprises FROM
        SNMPv2-SMI
        OBJECT-GROUP FROM SNMPv2-CONF
        DisplayString FROM SNMPv2-TC
    ;

yamahaAgentMIB MODULE-IDENTITY
    LAST-UPDATED "201710010000Z"
    ORGANIZATION "uc.yamaha.com"
    CONTACT-INFO
        "postal: Yamaha Unified Communications
            144 North Rd
            Sudbury, MA 01776
            email: uc-customersupport@music.yamaha.com"
    DESCRIPTION
        "Defines monitoring structures for the Yamaha SNMP agent for CS-700."
    REVISION "201710010000Z"
    DESCRIPTION "Initial revision"

    ::= { enterprises 1182 }

    cs700          OBJECT IDENTIFIER ::= { yamahaAgentMIB 7386 }
    cs700Traps    OBJECT IDENTIFIER ::= { cs700 1 }
    cs700TrapsObjects OBJECT IDENTIFIER ::= { cs700Traps 1 }

--
-- CS-700 objects
--

serial OBJECT-TYPE
    SYNTAX DisplayString
    MAX-ACCESS read-only
    STATUS current
    DESCRIPTION
        "Serial number of type String."
    ::= { cs700 11}

version OBJECT-TYPE
    SYNTAX DisplayString
    MAX-ACCESS read-only
    STATUS current
    DESCRIPTION
        "Base version of type String."
    ::= { cs700 12}

usbConnection OBJECT-TYPE
    SYNTAX DisplayString
    MAX-ACCESS read-only
    STATUS current
```

```

DESCRIPTION
"USB connection active (0,1) of type String."
::= {cs700 13}

usbMicStream OBJECT-TYPE
SYNTAX DisplayString
MAX-ACCESS read-only
STATUS current
DESCRIPTION
"USB microphone audio stream active (0,1) of type String."
::= {cs700 14}

usbSpkStream OBJECT-TYPE
SYNTAX DisplayString
MAX-ACCESS read-only
STATUS current
DESCRIPTION
"USB speaker audio stream active (0,1) of type String."
::= {cs700 15}

usbVidStream OBJECT-TYPE
SYNTAX DisplayString
MAX-ACCESS read-only
STATUS current
DESCRIPTION
"USB video stream active (0,1) of type String."
::= {cs700 16}

btConnected OBJECT-TYPE
SYNTAX DisplayString
MAX-ACCESS read-only
STATUS current
DESCRIPTION
"Bluetooth connection active (0,1) of type String."
::= {cs700 17}

voipCallStatus OBJECT-TYPE
SYNTAX DisplayString
MAX-ACCESS read-only
STATUS current
DESCRIPTION
"Current VoIP call lines 1-3 call state of type String."
::= {cs700 18}

--
-- CS-700 traps
--

usbConnTrap OBJECT-TYPE
SYNTAX DisplayString
MAX-ACCESS accessible-for-notify
STATUS current
DESCRIPTION "USB connection trap data"
::= { cs700TrapsObjects 1 }

usbConnTrapHit NOTIFICATION-TYPE
OBJECTS { usbconnTrap }

```

```
STATUS      current
DESCRIPTION "Generated when USB connection state changes"
::= { cs700Traps 1 }
```

## Dial Plan definition

The dial plan serves several purposes. It allows manipulating a number string that is entered on the dialer and instead sends a transformed string to the Call Manager. Or it allows checking for specific strings to be blocked for dialing. Any string dialed is checked against the dial plan and returns "no match", "match" or "reject". If "reject" is returned, the dial string will not be sent to the call manager and a busy tone is played. Strings that match will be replaced with the string defined in the dial plan and then that string is used to dial the number. Strings that do not match any of the rules will be used as they are to dial the number.

If no dial plan is set, the dialed numbers are used to setup a call on the call manager without any check.

Dial plans consist of a series of dial digits (0..9, \*, #) and modifiers ('x', '[]', '.', '<:>', '!', '^', '{}') separated by '|' .

NOTE: There should be no spaces in the dial plan. The examples below show spaces for readability only.

### Definition of modifiers

'x' represents a wildcard and matches any numeric digit ('0' .. '9')

'[]' defines a range

[389] represents '3' or '8' or '9'

[3-9] represents '3' or '4' or ... or '8' or '9'

'.' indicates to repeat the previous number or sub-string

"01." matches "0", "01", "011", "0111", etc.

'<:>' represents a substitution: '<' dialed subsequence ':' transmitted subsequence '>'

"<8:91650>xxxxxxx" would match "85551212" and replace it with "916505551212"

'!' is used to reject a sequence by placing it at the end of the sequence

"1900xxxxxxx!" will reject 900 area code numbers

'^' is used to exclude digits in the set of the range []

:

[^15] includes 0, 2, 3, 4, 6, 7, 8, 9 i.e. [02346789]

[^2-4] includes 0, 1, 5, 6, 7, 8, 9 i.e. [0156789]

The above modifiers are part of "DRegex" as defined in RFC4730.

## Examples

- <9:>xxxxxxx—Remove 9 at the beginning of the dialed number
  - For example, if the number 914539400 is dialed, the first 9 is removed when the call is placed.
- <:604>xxxxxxx—Prepend 604 to all seven digit numbers
  - For example, if a customer dials 4539400, 604 is added to the front of the number, so a call to 6044539400 is placed.
- <9:604>xxxxxxx—Replaces 9 with 604
- <999:911>—Convert 999 to 911
- xx<601:600>xx—When applied on 1160122 gives 1160022
- x<60x:600>xxxxxxx—Any 60x will be replaced with 600 in the middle of the dialed number that matches
  - For example, if a customer dials 16092345678, a call is placed to 16002345678.

### Examples:

This dial plan accepts only US-style 1 + area-code + local-number, with no restrictions on the area code and number:

- 1xxxxxxxxxx

This also allows seven-digit US-style dialing, and automatically inserts a 1 + 212 (local area code) in the transmitted number:

- 1xxxxxxxxxx|<:1212>xxxxxxx

For an office environment, the following plan requires a user to dial 8 as a prefix for local calls and 9 as a prefix for long distance. Neither prefix is transmitted when initiating the call.

- <9:>1xxxxxxxxxx|<8:1212>xxxxxxx

This allows US-style long distance, but blocks 9xx area codes:

- 1[2-8]xx[2-9]xxxxxx

This allows arbitrary long distance dialing, but explicitly blocks the 947 area code:

- 1947xxxxxx!|1xxxxxxxxxx

The following allows only US-style 1 + area-code + local-number, but disallows area codes and local numbers starting with 0 or 1. It also allows 411, 911, and operator calls (0):

- 0|[49]xx|1[2-9]xx[2-9]xxxxxx



## Optimize Windows for CS-700 Audio

To configure the CS-700 device as the default device and to improve audio follow this **one-time** setup procedure:

1. Right click on the speaker icon in the lower right hand corner of the Windows taskbar.
2. Select Sounds from the menu.
3. Click the Playback tab.
4. Right click on the Yamaha CS-700 Device.
5. Select “Set as Default Device” from the menu.
6. Right click on the Yamaha CS-700 Device again.
7. Select “Set as Default Communication Device” from the menu.
8. Right click on Yamaha CS-700 Device one more time.
9. Select Properties from the menu.
10. If there is an “Enhancements” tab, click on it.
11. Check the “Disable all enhancements” box.
12. Click on the Advanced tab.
13. Select “2 channel, 24 bit, 48000 Hz (Studio Quality)” from the drop-down menu under Default Format.
14. Click “Test.” You should hear the test jingle.
15. Click “Apply”, then “OK”.
16. Click the Recording tab.
17. Right click on the Yamaha CS-700 Device.
18. Select “Set as Default Device” from the menu.
19. Right click on the Yamaha CS-700 Device again.
20. Select “Set as Default Communication Device” from the menu.
21. Right click on the Yamaha CS-700 Device one more time.
22. Select Properties from the menu.
23. Click on the Levels tab.
24. Set the Microphone level to 50.
25. Click “OK”.
26. Click “OK” to close the Sound Window.

# Troubleshooting

## Reboot

From the Web UI, click on the “Restart Device” button on the home page and confirm the selection to reboot the system. Or from the Service Application, select “Restart system” in the Configuration Menu.

Removing the CS-700 device from power by disconnecting the Power connector will also shut down the unit. Reconnecting the unit will power it up again.

Finally, pressing the “Volume down” and “Bluetooth” areas for 5 seconds will also reboot the unit.

The Center Position Status LED should glow various colors during the boot process, and complete with White showing. The unit will sound a chime nearing the end of the booting process. Wait several minutes for reboot to complete, and for DHCP to assign an IP address.

## Restore Factory Defaults

From the Web UI or the Service application, open the “Configuration” menu under the “Tools” menu. On the bottom of the page, under the header “Reset Defaults”, select the areas you wish to reset, then click the “Reset Defaults” button on the right side of the page.

Pressing and holding the “MIC mute” and “Bluetooth” buttons simultaneously on the front panel for 5 seconds will also restore to factory defaults.

## Cannot Access Web UI

Check that the IP Address being used is correct. The IP Address of the CS-700 device is provided by simultaneously pressing and holding the “Volume-UP” and “Bluetooth” buttons on the front panel for five seconds. The CS-700 unit will announce the currently assigned IP Address. Input the whole IP Address, including periods, into the URL bar of the browser to access the Web UI. Verify this address is not conflicting with anything else on the network.

Please note that if “https” is selected for the web interface, browsers might provide warnings as no known certificate can be provided. Ignore these warnings to access the web interface.

If no IP Address is assigned, check that DHCP service is enabled on the network. If the application is set for NON-DHCP service, than IP Address

configuration will need to occur through the Service Application with a directly attached PC. See the section on Service Application.

If access issues continue, reboot the unit and re-verify that a valid IP Address is assigned by the network following several minutes of boot-up using the method described above.

## **Lost Password**

If the Web-UI and Service application password has been changed from factory default (7386), and the new password has been lost – access to the unit can be recovered in two ways.

1. Use Option-66 and TFTP server with provisioning file to reset the password. See section on Provisioning Server and Provisioning File to understand how to perform this operation. This will only work if the CS-700 unit is configured to attempt automatic provisioning (factory default). If the unit has automatic provisioning disabled, this method will not work.
2. Pressing and holding the “MIC mute” and “Bluetooth” buttons simultaneously on the front panel for 5 seconds will restore to factory defaults. It allows accessing with the factory default password (7386).  
**Please note this way loses all configured parameters.**

## **Low Camera Image Quality (Far-end video)**

Several factors can contribute to low-image quality delivered to the far-end of the video conference. The CS-700 is the physical end-point of a system of components that connect each-end of a video conference. All components in the chain must be validated to ensure the highest quality video is ultimately received. Several factors along the system chain include the following:

- USB Connection from CS-700 to the local PC device. This link must be at full 3.0 specification to ensure sufficient bandwidth necessary to support HD-video transfers.
  - This connection must be point-to-point; no USB HUBs.
  - This connection must use the USB 3.0 cable provided with CS-700, or if an extension is used, make sure that ONLY pre-approved extension cables are used.
  - The PC Port must support USB 3.0 for optimal video performance
- UC Software Video Management. Many Unified Communications Systems will often manage the transmitted video quality across the network to a lower-than-HD level to enhance reliable delivery. While CS-700 will

deliver true HD camera video to the UC software via USB 3.0, the UC software may down-sample the video to lower resolutions.

- Network bandwidth and service consistency. Network drop-outs and bandwidth restrictions can clearly affect the UC software and end-to-end connection, with greatest impact being degraded video quality, either with a resolution down-grade below HD, or through video artifacts and freezes during network service interruptions.
- Optimize Camera Settings. Assuming video degradation is not resolution or bandwidth related, various other camera settings can be optimized through the UC Software Control Panel/Camera Settings, including contrast, brightness, sharpness, Hue, and others.
- Check that the Power line frequency for anti-flicker is set correctly. When using fluorescent lighting, using the wrong frequency setting might lead to a flicker in the image. The frequency can either be set from the UC application if supported, or from the Service Application's Camera menu.

### **Misaligned Camera Image (Far-end video)**

If the camera is projecting a poorly framed (misaligned) image to the far-end. Or the conference room is configured such that the CS-700 is not symmetrically aligned with the Table and/or the display, causing the camera field of view to be misaligned.

In these cases adjust the vertical camera angle (see section Setting Up the System), then make additional camera pan/tilt/zoom adjustments as necessary to optimize for your room using the Service application.

### **No Camera Image at Far-end**

- Ensure that Camera Mute is not enabled (showing red). If Camera Mute is enabled, the far end should see a large "pause" image.
- Ensure that UC Software properly sees and enables the Yamaha CS-700 Camera device within the software settings.

## Technical Specifications

<b>Power adapter</b>	
Model Number	ADP-38DR A
<b>Bluetooth Specifications</b>	
Bluetooth specification version	2.1 + EDR
Supported profiles	HFP (1.6), A2DP
Supported Codecs	SBC, mSBC, CVSD
Wireless output	Class 2
Maximum communication distance	10 m
Radio frequency (Operational frequency)	2,402 MHz to 2,480 MHz
Maximum output power (EIRP)	4.0 dBm (2.5 mW)
<b>Audio</b>	
Speaker Bar	4 Speaker elements with tweeter and mid-Woofer on left and right
Speaker Frequency Response	160 – 20,000 Hz
Max SPL	90 dB at 1m
Microphones	4 microphone dynamic beamforming array with human voice activity detection
Microphone Coverage	120 degrees audio pickup, best results within 12 feet / 3.60m
Microphone Frequency Response	160 – 16,000 Hz
Full Duplex Audio	Yes
Echo Cancellation	Ultra-wideband adaptive AEC
LED indicator	Call activity and microphone mute/unmute
<b>Video</b>	
Camera Sensor	High Definition CMOS
Image resolution	1080p, 30 fps (USB 3.0/3.1) 640 x 360, 30 fps (USB 2.0)
Privacy	Digital privacy control
LED Indicators	Camera activity and video stream mute/unmute
UVC Support	UVC 1.5
Field of View	120 degrees diagonally
Maximum Zoom	4.00
<b>Interfaces</b>	
Mount Connector	Wall Mount Bracket for above or below display mounting
USB Port	USB with strain relief Audio, video, HID and graphics display supported over USB 2.0 and 3.0/3.1
Multipurpose USB port	USB port supporting external USB devices. USB 3.1 Gen 1
Ethernet	RJ 45, 10M / 100M
Bluetooth®	Yes. HFP and A2DP support
Aux Audio Input	3.5mm Stereo
<b>SIP (-SP models only)</b>	
Call Handling	Make, Answer, Hold, Resume, Transfer (Blind and Supervised), Forwarding, Do not disturb, Redial, Call Timer, Call ID, Speed Dial, Missed Call Notifications, Voice Mail Notifications (Call Manager configured)

Call Bridging	Supports Bridging SIP and USB Calls. Join, Split, Hold, Resume, 2+1+1 Lines: Up to 2 SIP calls, 1 USB call, 1 Bluetooth® call, plus the user
Codecs	G.711 (A-law and $\mu$ -law), G.722, G.726, G.729
DTMF Support	RTP event, SIP in-band, SIP info package
Security	SRTP/SRTCP Support (RFC 1889), IETF SIP support (RFC 3261 and companion RFCs), SSIP, Password protected configuration files, Password protected login
Network & Provisioning	DHCP or Static IP, Server Based Central Provisioning, Web Portal for Individual Unit Configuration
<b>Compliance</b>	
Safety	IEC60065, IEC60950, IEC62368
EMC	CISPR13/CISPR22/CISPR32/ FCC/J55013/ ETSI EN 300 328 / ETSI EN 302 291-2 / ETSI EN 300 330-2 EN55024/ CISPR24 or 35 and ETSI EN 301 489-1
Environmental	RoHS, Reach, WEEE
<b>Warranty</b>	
Global except for EU	1 Year return to factory
European Union	2 Year return to factory
<b>Size, Weight, Power, Operating Temperature</b>	
Height	3.9in/98.75mm
Length	2.7in/68.5mm
Width	34.in/861.7mm
Weight (incl. bracket)	7.3 lbs/3.3kg
Input Voltage (power supply)	100-240 VAC
Input Current (power supply)	1A
Input Frequency (power supply)	50-60 Hz
Input Voltage (CS-700)	15V
Input Current (CS-700)	2.4A
Power consumption (max)	36 W
Power consumption (network stand-by)	2.6 W
Stand-by time	20 minutes (user selectable)
Power Cord Length	10ft/3m - Please order correct SKU for regional power cord requirements
Operating Temperature	32 to 104 °F (0 to 40 °C)
Storage Temperature	-22 to 131 °F (-30 to 55 °C)
Operating / Storage Relative Humidity	20%-85% (non-condensing)
Maximum operating altitude	2,000m

## **Date code**

The date code on the CS-700 label indicates when the product was manufactured. The first digit indicates the year.

First digit	Calendar year
7	2017
8	2018
9	2019
0	2020
1	2021

The second and third digits indicate the calendar week in that year – from 01 at the beginning of the year to 52 (or 53).

For clarification, the year and months are also provided in the format YYYY/MM.

## **Limited Warranty and Limitation of Liability**

### **Limited Warranty**

Yamaha Unified Communications warrants to the end user (“Customer”) that this product will be free from significant defects in workmanship and materials, under normal use and service, for one year from the date of purchase from Yamaha Unified Communications or its authorized reseller provided the customer provides proof of purchase that demonstrates that the product is still within the warranty period and contacts Yamaha Unified Communications customer service, regarding warranty claims, within the warranty period. Yamaha Unified Communications’ sole obligation under this express warranty shall be, at Yamaha Unified Communications’ option and expense, to repair the defective product or part, deliver to Customer an equivalent product or part to replace the defective item, or if neither of the two foregoing options is reasonably available, Yamaha Unified Communications may, in its sole discretion, refund to Customer the purchase price paid for the defective product upon Customer’s return of the defective product. All products that are replaced will become the property of Yamaha Unified Communications. Replacement products or parts may be new or reconditioned. Yamaha Unified Communications warrants any replaced or repaired product or part for ninety (90) days from shipment, or the remainder of the initial warranty period, whichever is longer. Products returned to Yamaha Unified Communications must be issued a valid Return Material Authorization (“RMA”) number. To request an RMA, contact Yamaha Unified Communications Customer Service. Prior to receiving an RMA, the product must be first troubleshot and determined to be defective by a Yamaha Unified Communications Technical Support Technician. Product returned to Yamaha Unified Communications must have a valid RMA # clearly marked on the outside of the shipping container and the serial number and model of the returned product must match the RMA. Products returned without a RMA number will be returned to the customer. The product must contain all of the original accessories and be properly packaged. Products returned to Yamaha Unified Communications must be sent prepaid, and it is recommended that they be insured or sent by a method that provides for tracking of the package. Responsibility for loss or damage does not transfer to Yamaha Unified Communications until the returned item is received by Yamaha Unified Communications. The repaired or replaced item will be shipped to Customer, via standard economy shipping methods and at Yamaha Unified Communications’ expense, not later than thirty (30) days after Yamaha Unified Communications receives the defective



product, and Yamaha Unified Communications will retain risk of loss or damage until the item is delivered to Customer. Any customer request for expedited shipping will be considered on a case-by-case basis and will be at the sole expense of the customer. Any product found to be not covered under the terms of this warranty, per the exclusions listed below, will be treated as an out-of-warranty service and will be billed to the customer according to the Yamaha Unified Communications Product Repair Policy. The sole exceptions to the terms of this warranty are those listed as part of the Yamaha Unified Communications DOA Replacement Policy.

## **Exclusions and Remedies**

Yamaha Unified Communications will not be liable under this limited warranty if its testing and examination disclose that the alleged defect or malfunction in the product does not exist or results from:

- ▶ Failure to follow Yamaha Unified Communications' installation, operation, or maintenance instructions;
- ▶ Product modification or alteration, including but not limited to modification or removal of the serial number.
- ▶ Use of common carrier communication services accessed through the product;
- ▶ Failure of Consumable Components and Accessories including but not limited to batteries and cables.
- ▶ Abuse, misuse, negligent acts or omissions of Customer and persons under Customer's control; or
- ▶ Acts of third parties or products, acts of God, accident, fire, lightning, power surges, outages, or other hazards, or any other cause outside of Yamaha Unified Communications' reasonable control.

## **WARRANTY EXCLUSION**

IF A YAMAHA UNIFIED COMMUNICATIONS PRODUCT DOES NOT OPERATE AS WARRANTED ABOVE, CUSTOMER'S SOLE REMEDY FOR BREACH OF THAT WARRANTY SHALL BE REPAIR, REPLACEMENT, OR REFUND OF THE PURCHASE PRICES PAID, AT YAMAHA UNIFIED COMMUNICATIONS'S OPTION. TO THE FULL EXTENT ALLOWED BY LAW, THE FOREGOING WARRANTIES AND REMEDIES ARE EXCLUSIVE AND ARE IN LIEU OF ALL OTHER WARRANTIES, TERMS OR CONDITIONS, EXPRESS OR IMPLIED, EITHER IN FACT OR BY OPERATION OF LAW, STATUTORY OR OTHERWISE, INCLUDING WARRANTIES, TERMS OR CONDITIONS OF MERCHANTABILITY, FITNESS FOR A PARTICULAR PURPOSE, SATISFACTORY QUALITY, CORRESPONDENCE WITH DESCRIPTION, AND NONINFRINGEMENT, ALL OF

WHICH ARE EXPRESSLY DISCLAIMED. YAMAHA UNIFIED COMMUNICATIONS NEITHER ASSUMES NOR AUTHORIZES ANY OTHER PERSON TO ASSUME FOR IT ANY OTHER LIABILITY IN CONNECTION WITH THE SALE, INSTALLATION, MAINTENANCE OR USE OF ITS PRODUCTS.

### **Limitation of Liability**

TO THE FULL EXTENT ALLOWED BY LAW, YAMAHA UNIFIED COMMUNICATIONS EXCLUDES FOR ITSELF AND ITS SUPPLIERS ANY LIABILITY, WHETHER BASED IN CONTRACT OR TORT (INCLUDING NEGLIGENCE), FOR INCIDENTAL, CONSEQUENTIAL, INDIRECT, SPECIAL, OR PUNITIVE DAMAGES OF ANY KIND, OR FOR LOSS OF REVENUE OR PROFITS, LOSS OF BUSINESS, LOSS OF INFORMATION OR DATA, OR OTHER FINANCIAL LOSS ARISING OUT OF OR IN CONNECTION WITH THE SALE, INSTALLATION, MAINTENANCE, USE, PERFORMANCE, FAILURE, OR INTERRUPTION OF ITS PRODUCTS, EVEN IF YAMAHA UNIFIED COMMUNICATIONS OR ITS AUTHORIZED RESELLER HAS BEEN ADVISED OF THE POSSIBILITY OF SUCH DAMAGES, AND LIMITS ITS LIABILITY TO REPAIR, REPLACEMENT, OR REFUND OF THE PURCHASE PRICE PAID, AT YAMAHA UNIFIED COMMUNICATIONS'S OPTION. THIS DISCLAIMER OF LIABILITY FOR DAMAGES WILL NOT BE AFFECTED IF ANY REMEDY PROVIDED HEREIN SHALL FAIL OF ITS ESSENTIAL PURPOSE.

### **Disclaimer**

Some countries, states, or provinces do not allow the exclusion or limitation of implied warranties or the limitation of incidental or consequential damages for certain products supplied to consumers, or the limitation of liability for personal injury, so the above limitations and exclusions may be limited in their application to you. When the implied warranties are not allowed to be excluded in their entirety, they will be limited to the duration of the applicable written warranty. This warranty gives you specific legal rights which may vary depending on local law.

### **Governing Laws**

This Limited Warranty and Limitation of Liability shall be governed by the laws of the Commonwealth of Massachusetts, USA, and by the laws of the United States, excluding their conflicts of laws principles. The United Nations Convention on Contracts for the International Sale of Goods is hereby excluded in its entirety from application to this Limited Warranty and Limitation of Liability.

## Open Source Software

The following table lists the open source software in the CS-700 products and the respective licenses under which these software packages are used.

The specific Open Source software packages used in the CS-700 product are:

Name	Version	License Type
psp_linux	12.0	GNU GPLv2
psp_omap	3.20.00.14	GNU GPLv2
mtd-utils	1.0	GNU GPLv1
udev	055	GNU GPLv2
busybox	1.00	GNU GPLv2
buildroot	2013.08.1	GNU GPLv2
glibc	2.3.3	GNU LGPLv2.1
Tecla Library	1.6.2	Free Software License
cURL	7.33.0	MIT
OpenSSH	6.8	BSD
CMU Flite	2.0.0	Free Software License
Etest	1.23	GNU GPLv2
OpenLLDP	0.4alpha	GNU GPLv2
pjsip	2.2.1	GNU GPLv2
ezXML	0.8.6	MIT
BlueZ Interface	5.46	GNU GPLv2
Net-SNMP	5.7.3	BSD
Angular	2	MIT
Libusb	1.0.22	GNU LGPLv2.1
Android SDK	5+	Apache 2
Camera_NET	1.1.2	GNU LGPL 3
lighttpd	1.4.49	BSD
flite	2.0.0	BSD
wpa_supplicant	2.x	BSD
libsrtp	1.4.2	Cisco
Json-c	0.9	Metaparadigm Pte Ltd

The different software licenses and license templates can be found on the internet at the following addresses:

License Type	Supplier Name / Web Address
GNU GPLv1	<a href="https://www.gnu.org/licenses/gpl-1.0.html">https://www.gnu.org/licenses/gpl-1.0.html</a>
GNU GPLv2	<a href="http://www.gnu.org/licenses/gpl-2.0.html">http://www.gnu.org/licenses/gpl-2.0.html</a>
GNU LGPLv2.1	<a href="http://www.gnu.org/licenses/lgpl-2.1.html">http://www.gnu.org/licenses/lgpl-2.1.html</a>
GNU LPGL 3	<a href="http://www.gnu.org/licenses/lgpl.html">http://www.gnu.org/licenses/lgpl.html</a>
BSD	<a href="http://opensource.org/licenses/BSD-2-Clause">http://opensource.org/licenses/BSD-2-Clause</a>
MIT	<a href="http://opensource.org/licenses/MIT">http://opensource.org/licenses/MIT</a>
Free Software License	<a href="http://www.astro.caltech.edu/~mcs/tecla/LICENSE.TERMS">http://www.astro.caltech.edu/~mcs/tecla/LICENSE.TERMS</a>
Apache 2	<a href="http://www.apache.org/licenses/LICENSE-2.0">http://www.apache.org/licenses/LICENSE-2.0</a>

Cisco	<a href="https://github.com/cisco/libsrtp">https://github.com/cisco/libsrtp</a>
Metaparadigm Pte Ltd	<a href="https://github.com/json-c/json-c/blob/master/COPYING">https://github.com/json-c/json-c/blob/master/COPYING</a>

Source code for these open source software packages can be obtained by contacting Yamaha Unified Communications at [uc-support@music.yamaha.com](mailto:uc-support@music.yamaha.com).

© Yamaha Corporation. All Rights Reserved.

Published 3/2020 F0

MN-CS700-202003-EN / 295 02 74-00



Manufacturer: Yamaha Unified Communication, Inc.  
Address: 144 North Road, Suite 3250  
Sudbury, MA 01776, USA